

# Panasonic<sup>®</sup>



## LUMIX

# Operating Instructions for advanced features/ Owner's Manual for advanced features

Digital Camera

Model No. DC-TZ99/DC-ZS99

Please read these instructions carefully before using this product,  
and save this manual for future use.

The firmware has been updated to improve camera capabilities, add functionality, and enhance security.

- For details, refer to the "[Firmware Update](#)" pages.

**Message displays** →265

**Q&A Troubleshooting** →267

Finding the information you need →2

Contents →5

Contents by Function →11

Names and Functions of Main Parts →16

Menu list →166







Register online at  
<http://shop.panasonic.com/support/register>  
(U.S. customers only)

DVQP3285ZC  
M0125KZ2036

## Finding the information you need

In this “Operating Instructions for advanced features / Owner’s Manual for advanced features”, you can find the information you need from the following pages.

By clicking a page number, you can jump to the linked page and quickly find the information.



<b>Search from “Contents”</b>	 <b>5 -</b>
<b>Search from the list of function names</b> “Contents by Function”	 <b>11 -</b>
<b>Search from “Names and Functions of Main Parts”</b>	 <b>16 -</b>
<b>List of monitor displays</b>	 <b>259 -</b>
<b>Search from the list of on-screen messages</b> “Message displays”	 <b>265 -</b>
<b>Search from the menu list</b>	 <b>166 -</b>
<b>Search from “Q&amp;A Troubleshooting”</b>	 <b>267 -</b>

**For details on how to use this manual, see the next page.**

## Recording mode icons

Recording mode: 

In Recording modes that show icons in black, you can select and execute indicated menus and functions.

 /  (Custom Mode) has different functions depending on the recording mode that is registered.

- Click a cross reference in the text to jump to the corresponding page.

## ■ About the symbols in the text

**MENU** Indicates that the menu can be set by pressing [MENU/SET] button.

**Wi-Fi** Indicates that the Wi-Fi setting can be made by pressing [Wi-Fi] button.



Tips for skillful use and points for recording.

(→00) Indicates the reference page. Click to go to the corresponding page.



Steps for setting a menu item are described as follows:

Example: To change the [Quality] setting to [.] in the [Rec] menu

**MENU** →  **[Rec]** → **[Quality]** → [.]

- This Operating Instructions expresses the up, down, left, and right of the cursor button as ▲▼◀▶.
- Dial and lever operations are illustrated as below.



Rotate the control dial	
Rotate the zoom lever	

- The external design and specifications of this product, as described in this document, may differ from the actual product.
- Illustrations used in this document may differ from the actual product and the actual images displayed on the product.
- Images used in this document are sample pictures used to explain the functions and effects.

■ Finding the information you need ..... 2	■ Contents by Function ..... 11
■ How to use this manual ..... 3	

## Before Use

---

■ Before use ..... 13	■ Names and Functions of Main Parts ..... 16
■ Standard Accessories ..... 15	

## Preparations

---

■ Attaching the Hand Strap ..... 18	■ About the Card ..... 27
■ Charging battery ..... 19	Formatting the card (initialization) ..... 28
Inserting the battery ..... 20	Estimated recording capacity (number of pictures/recording time) ..... 28
Charging the battery ..... 21	■ Setting the clock ..... 31
■ Inserting and removing the card (optional) ..... 26	

## Basics

---

■ Holding the camera ..... 33	■ Setting the menu ..... 45
■ Adjusting the angle of the monitor ..... 34	■ Calling frequently-used menus instantly (Quick Menu) ..... 47
■ Basic Operation ..... 35	■ Assigning frequently used functions to the buttons (Function buttons) ..... 48
Zoom Lever (Use Zoom) ..... 35	Using the function buttons during recording ..... 49
[Zoom Compose Assist] button (Using the Zoom Compose Assist function) ..... 36	Using the function buttons during playback ..... 50
Shutter button (Taking pictures) ..... 37	■ Changing the settings assigned to the control ring/control dial ..... 51
Motion picture button (Recording motion pictures) ..... 38	■ Entering Text ..... 52
Mode dial (Select the recording mode) ..... 38	
Control ring / Control dial ..... 39	
Cursor button / [MENU/SET] button (Selecting/setting items) ..... 40	
[DISP.] button (Switching the display information) ..... 40	
Touch screen (Touch operations) ..... 42	
Taking pictures using the touch function ..... 43	

## Recording mode

- **Taking pictures with automatic settings (Intelligent Auto Mode) ..... 53**
  - [Intelligent Auto] menu ..... 55
  - Setting coloring ..... 56
  - Setting brightness (exposure)/ blurriness of the background (Defocus control function) ..... 57
- **Taking Pictures of Yourself [Self Shot] ..... 58**
  - Taking pictures of yourself in 4K Photo Mode (4K Selfie) ..... 62
- **Taking pictures after automatically setting the aperture value and shutter speed (Program AE Mode) ..... 64**
- **Taking pictures by setting the aperture value and shutter speed ... 66**
  - Taking pictures by setting the aperture value (Aperture-Priority AE Mode) ..... 66
  - Taking pictures by setting the shutter speed (Shutter-Priority AE Mode) ..... 67
  - Taking pictures by setting the aperture value and shutter speed (Manual Exposure Mode) ..... 68
  - Checking the effects of the aperture value and shutter speed (Preview Mode) ..... 69
  - Easily set aperture value / shutter speed for suitable exposure (One Push AE) ..... 70
- **Taking pictures according to the scene (Scene Guide Mode) ..... 71**
- **Taking Pictures with different picture effects (Creative Control Mode) ..... 75**
- **Recording motion pictures by setting the aperture/ shutter speed/ISO sensitivity (Creative Video Mode) ..... 81**
  - Recording Slow Motion Pictures ([High Speed Video]) ..... 82
  - Pan or zoom while recording with the camera in a fixed position ([4K Live Cropping]) ..... 84
- **Registering your own settings and recording (Custom Mode) ..... 86**
  - Registering your own settings ([Cust.Set Mem.]) ..... 86
  - Recording using registered custom set ..... 87

## Focus, Brightness (Exposure) and Color tone Settings

■ <b>Taking pictures with Auto Focus</b> ..... 88	■ <b>Taking pictures with Manual Focus</b> ..... 101
Set the Focus Mode (AFS, AFF, AFC).....89	
Switching [AF Mode].....90	■ <b>Taking pictures by locking the focus and/or exposure (AF/AE Lock)</b> ..... 103
Changing the position and size of the AF area .....96	■ <b>Taking pictures with Exposure Compensation</b> ..... 104
Optimizing the focus and brightness for a touched position .....99	■ <b>Setting the ISO Sensitivity</b> ..... 105
■ <b>Taking close-up pictures (Macro recording)</b> ..... 100	■ <b>Adjusting the White Balance</b> ..... 107

## 4K Photo and Drive Settings

■ <b>Selecting a Drive Mode</b> .....111	■ <b>Taking pictures with self-timer</b> ..... 130
■ <b>Burst function</b> ..... 112	■ <b>Taking pictures automatically at set intervals [Time Lapse Shot]</b> ..... 131
■ <b>Recording with the 4K Photo function and selecting pictures to save</b> ..... 114	■ <b>Creating stop motion animation [Stop Motion Animation]</b> ..... 134
Recording with the 4K Photo function ..... 114	■ <b>Taking Pictures While Adjusting a Setting Automatically (Bracket Recording)</b> ..... 137
Selecting pictures from 4K burst file and saving ..... 117	Exposure Bracket ..... 138
Notes on the 4K Photo function ..... 122	
■ <b>Adjusting the focus after recording ([Post Focus]/[Focus Stacking])</b> .... 125	
Recording using [Post Focus]..... 125	
Select the focus point and save the picture ([Post Focus])..... 127	
Select the focus range to combine and create a single picture ([Focus Stacking])..... 128	
Notes on the [Post Focus]/[Focus Stacking] ..... 129	

## Stabilizer, Zoom and Flash

---

- **Correcting jitter** ..... 139
- **Using Zoom** ..... 141
  - Zoom types and use ..... 141
  - Using the zoom by performing touch operations (Touch zoom) ..... 144
- **Taking pictures with flash** ..... 145
  - Changing Flash Mode ..... 145
  - Adjusting the flash output ..... 148

## Recording motion pictures

---

- **Recording Motion Pictures** ..... 149
  - Setting the picture size and recording frame rate ..... 151
  - Adjusting the focus while recording motion pictures ([Continuous AF]) ..... 153
- **Taking still pictures while a motion picture is being recorded** ..... 154
- **Recording Snap Movies** ..... 155

## Playing Back and Editing Pictures

---

- **Viewing your pictures** ..... 158
- **Viewing motion pictures** ..... 159
  - Capturing still pictures from motion pictures ..... 160
- **Switching the Playback Method** .... 161
  - Zooming in and viewing "Playback Zoom" ..... 161
  - Viewing a list of pictures "Multi Playback" ..... 162
  - Viewing pictures by their recording date "Calendar Playback" ..... 162
- **Viewing group pictures** ..... 163
- **Deleting pictures** ..... 165

## Using Menu Functions

■ <b>Menu list</b> .....	<b>166</b>	[Setup] .....	195
[Rec] .....	167	[My Menu] .....	205
[Motion Picture] .....	179	[Playback] .....	206
[Custom] .....	181		

## Wi-Fi/Bluetooth

■ <b>What you can do with the Wi-Fi®/Bluetooth® function</b> .....	<b>222</b>	■ <b>Sending pictures to a smartphone</b> .....	<b>242</b>
■ <b>Wi-Fi/Bluetooth Function</b> .....	<b>223</b>	■ <b>About Wi-Fi connections</b> .....	<b>246</b>
■ <b>Connecting the camera to a smartphone</b> .....	<b>226</b>	Connecting quickly with the same settings as used previously ([Select a destination from History] / [Select a destination from Favorite]) .....	246
Installing the smartphone/tablet app "Panasonic Image App" .....	226	■ <b>[Wi-Fi Setup]</b> .....	<b>248</b>
Connecting the camera to a smartphone compatible with Bluetooth Low Energy .....	227		
Connecting the camera to a smartphone that does not support for Bluetooth Low Energy .....	230		
■ <b>Controlling with a Smartphone</b> .....	<b>232</b>		
Turning on/off the camera using a smartphone .....	232		
Operating the shutter button of the camera using a smartphone (remote recording) .....	233		
Playing back or saving images stored on the camera .....	236		
Transferring recorded images to a smartphone automatically .....	237		
Writing location information of a smartphone on a recorded image .....	239		
Synchronizing the camera's clock with a smartphone .....	240		
Combining motion pictures recorded with Snap Movie according to your preference on a smartphone .....	240		

## Connecting with other devices

---

- **Enjoying 4K motion pictures ..... 249**
  - Viewing 4K motion pictures .....249
  - Storing 4K motion pictures.....249
- **Viewing on TV screen..... 250**
  - VIERA Link (HDMI) (HDAVI Control™)....251
- **Storing recorded still pictures and motion pictures on your PC ... 252**
  - Downloading software .....253
  - Copying still pictures and motion pictures .....255
- **Storing recorded still pictures and motion pictures in the recorder ..... 257**

## Others

---

- **Optional accessories ..... 258**
  - Tripod Grip (Optional) .....258
- **List of monitor displays ..... 259**
- **Message displays ..... 265**
- **Q&A**
  - Troubleshooting..... 267
- **Usage cautions and notes ..... 275**



## Recording

### Recording

[Zoom Compose Assist].....	36
Recording mode .....	38
Self Shot Mode .....	58
[Preview].....	69
Macro recording.....	100
[Time Lapse Shot].....	131
[Stop Motion Animation].....	134
Bracket recording .....	137
[Silent Mode].....	176

### 4K Photo

[4K PHOTO].....	114
[Post Focus] recording.....	125

### Focus (AF/MF)

Auto Focus .....	88
Focus mode.....	89, 101
AF Mode .....	90
Adjusting the AF area position.....	96
Manual Focus.....	101
AF/AE Lock.....	103

### Drive

Drive Mode .....	111
Burst function.....	112
[Self Timer] .....	130

### Exposure

[Touch AE] .....	44
[One Push AE] .....	70
AF/AE Lock.....	103
Exposure Compensation .....	104
ISO sensitivity.....	105
Exposure Bracket .....	138
[Metering Mode].....	173

### Picture Quality and Color Tone

White Balance .....	107
[Picture Size] .....	168
[Quality] .....	168
[Photo Style].....	169
[Filter Settings].....	171
[i.Dynamic].....	174
[i.Resolution].....	174
[Diffraction Compensation] .....	176
[HDR].....	178

### Flash

[Flash Mode].....	145
[Flash Adjust.] .....	148



## Motion Picture

### Motion Picture

Creative Video Mode .....	81
[High Speed Video].....	82
[4K Live Cropping] .....	84
[Rec Quality] .....	151
Taking still pictures while a motion picture is being recorded .....	154
[Snap Movie].....	155
[Vertical Position Info (Video)] .....	191

### Audio

[Wind Noise Canceller] .....	180
------------------------------	-----

### Screen settings

[Monochrome Live View] .....	187
[Center Marker].....	188
[Zebra Pattern].....	189



## Setup/Custom

### Basic settings

[Format] .....	28
[Clock Set] .....	31
Quick Menu .....	47
[Beep] .....	197
[Power Save Mode] .....	198
[Reset] (initialization) .....	204

### Customization

Function buttons .....	48
Custom Mode .....	86
[Custom] menu .....	181



## Playback

### Playback

Picture playback .....	158
Motion picture playback .....	159
Playback Zoom .....	161
Multi Playback .....	162
Delete .....	165
[Auto Review] .....	186
[Slide Show] .....	207
[Rotate]/[Rotate Disp.] .....	219, 221

### Edit

[Post Focus] .....	127
[Focus Stacking] .....	128
[Title Edit] .....	210
[RAW Processing] .....	211
[4K PHOTO Bulk Saving] .....	213
[Light Composition] .....	214
[Sequence Composition] .....	215
[Clear Retouch] .....	216
[Text Stamp] .....	217
[Resize] .....	218
[Cropping] .....	219

### Image settings

[Protect] .....	209
[Rating] .....	209



## Wi-Fi/Bluetooth

### Image App

Image App .....	226
Remote start-up .....	232
Remote recording .....	233
Auto transfer .....	237



## Connecting with other devices

### PC

Transferring images to a PC .....	252
PHOTOfunSTUDIO .....	253
SILKYPIX .....	254

### TV

Playing back pictures on a TV screen .....	250
[VIERA Link] .....	251

### Recorder

Dubbing .....	257
---------------	-----

## Before use

### ■ Camera handling

#### **Keep the camera away from excessive vibration, force, or pressure.**

- Avoid using the camera under the following conditions, which may damage the lens, monitor, or camera body.

This may also cause the camera to malfunction or prevent recording.

- Dropping or hitting the camera against a hard surface
- Sitting down with the camera in your pants pocket or forcing it into a full bag
- Adding accessories to the camera strap
- Pushing with excessive force on the lens or monitor
- If the camera [ON/OFF] button is pressed unintentionally while the camera is in a bag or pocket, the power will turn on and the lens barrel will extend. Applying pressure to the lens barrel can cause it to malfunction, so if you want to reduce the risk of the power turning on unintentionally, we recommend setting [Power Button(At Power ON)] to [LONG-PRESS] in the [Setup] menu. (→198)

#### **The camera is not dust resistant, splash resistant, or waterproof.**

#### **Avoid using the camera in places with excessive dust or sand, or where water can come into contact with the camera.**

- Avoid using the camera under the following conditions, which present a risk that sand, water, or foreign material may enter the camera through the lens or openings around buttons. Be especially careful because these conditions may damage the camera, and such damage may not be repairable.
  - In extremely dusty or sandy places
  - In the rain or by the shore, where the camera may be exposed to water

#### **If sand, dust, or liquids such as water droplets adhere to the monitor, wipe them off with a dry soft cloth.**

- Not doing so may cause the monitor to respond incorrectly to touch operations.

### ■ Condensation (When the lens or the monitor is fogged up)

- Condensation may occur when the camera is exposed to sudden changes of temperature or humidity. Avoid these conditions, which may make the lens or monitor dirty, cause mold, or damage the camera.
- If condensation does occur, turn off the camera and wait about two hours before using it. Once the camera adjusts to the surrounding temperature, the fogging will clear naturally.

**■ Always take a test shot first**

Before important events when you will use the camera (at weddings, for example), always take a test shot to make sure that pictures and sound record correctly.

**■ No compensation for missed shots**

We cannot compensate for missed shots if technical problems with the camera or card prevent recording.

**■ Carefully observe copyright laws**

Unauthorized use of recordings that contain works with copyright for purposes other than personal use is prohibited under copyright law. Recording of certain material may be restricted even for the purpose of personal use.

**■ Also refer to “Usage cautions and notes” (→275)****■ Before using the camera, make sure all accessories specified in the attached “Basic Operating Instructions / Basic Owner’s Manual” are supplied.**

For details on the optional accessories, refer to (→258) or “Basic Operating Instructions / Basic Owner’s Manual”.

## Standard Accessories

Check that all the accessories are supplied before using the camera.

- The accessories and their shape will differ depending on the country or area where the camera was purchased.

For details on the accessories, refer to “Basic Operating Instructions / Basic Owner’s Manual”.

- Battery Pack is indicated as battery pack or battery in the text.
- SD Memory Card, SDHC Memory Card and SDXC Memory Card are indicated as card in the text.
- **Cards are optional.**
- Please dispose of all packaging appropriately.
- Keep small parts in a safe place out of the reach of children.

### ■ **Optional accessories** (→258)

## Names and Functions of Main Parts

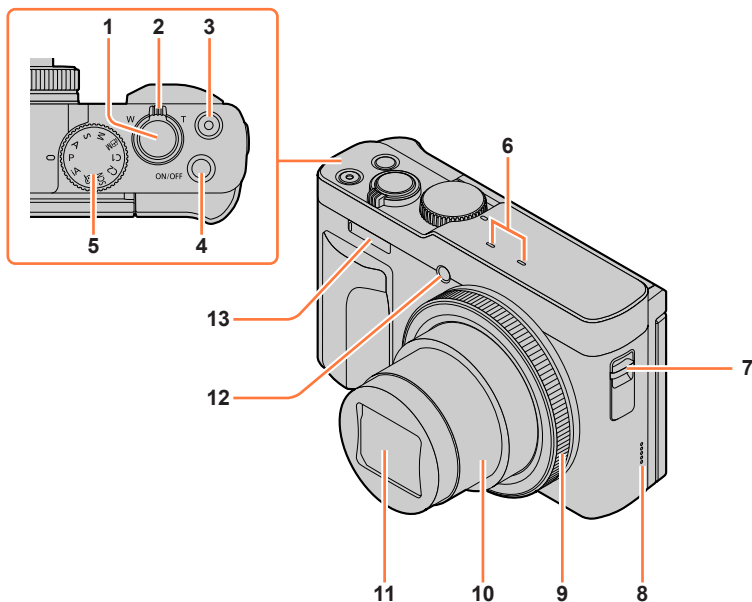

- |   |   |
|---|---|
| 1 | Shutter button (→37)  |
| 2 | Zoom lever (→35, 141, 186)  |
| 3 | Motion picture button (→38, 149)  |
| 4 | Camera [ON/OFF] button (→31)  |
| 5 | Mode dial (→38)   |
| 6 | Stereo microphone (→33, 180)<br>Be careful not to cover the microphone with your finger. Doing so may make sound difficult to record. |

- |    |  |
|----|--|
| 7  | Strap eyelet (→18)   |
| 8  | Speaker (→33, 197)   |
| 9  | Control ring (→39, 51)                                     |
| 10 | Lens barrel  |
| 11 | Lens   |
| 12 | Self-timer indicator (→130) /<br>AF Assist Lamp (→33, 183) |
| 13 | Flash (→33, 145)   |

## Names and Functions of Main Parts

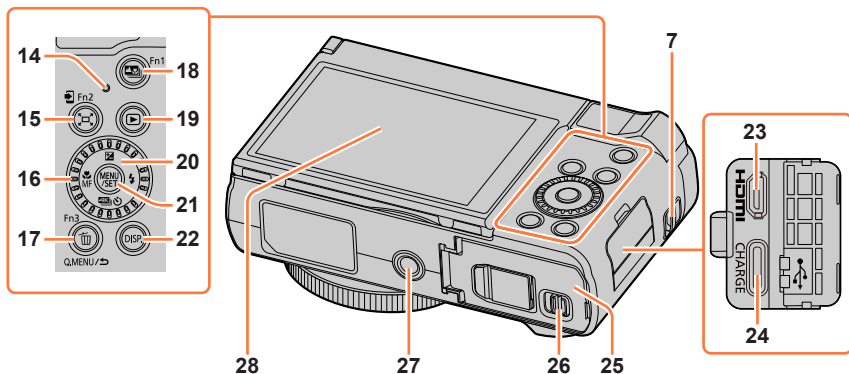

- |           |   |           |   |
|-----------|---|-----------|---|
| <b>7</b>  | <b>Strap eyelet</b> (→18)   | <b>21</b> | <b>[MENU/SET] button</b> (→40, 45)  |
| <b>14</b> | <b>Charging lamp</b> (→22) / <b>WIRELESS connection lamp</b> (→197, 223)  | <b>22</b> | <b>[DISP.] button</b> (→40)   |
| <b>15</b> | <b>[ZOOM ASSIST]</b> ([Zoom Compose Assist]) button (→36) / <b>[SEND IMAGE]</b> ([Send Image (Smartphone)]) button (→245) / <b>[Fn2] button</b> (→48)   | <b>23</b> | <b>[HDMI] socket</b> (→250)   |
| <b>16</b> | <b>Control dial</b> (→39, 51)   | <b>24</b> | <b>[USB/CHARGE] socket</b> (→21, 255)   |
| <b>17</b> | <b>[DELETE]</b> ([Delete]) button (→165) / <b>[Q.MENU] button</b> (→47) / <b>[CANCEL]</b> ([Cancel]) button (→46) / <b>[Fn3] button</b> (→48)   | <b>25</b> | <b>Card/Battery door</b> (→20, 26)  |
| <b>18</b> | <b>[POST FOCUS]</b> ([Post Focus]) button (→125) / <b>[Fn1] button</b> (→48)  | <b>26</b> | <b>Release lever</b> (→20, 26)  |
| <b>19</b> | <b>[PLAYBACK] button</b> (→158)   | <b>27</b> | <b>Tripod mount</b> (→278)<br>Do not attach this unit to tripods that have screws with a length of 5.5 mm (0.22 inch) or more. Doing so may damage this unit or the unit may not be secured properly on the tripod. |
| <b>20</b> | <b>Cursor button</b> (→40)<br><b>[EXPOSURE COMPENSATION]</b> ([Exposure Compensation]) (▲) (→104)<br><b>[FLASH]</b> ([Flash]) (▶) (→145)<br><b>[DRIVE MODE]</b> ([Drive Mode]) (▼) (→111)<br><b>[FOCUS MODE]</b> ([Focus Mode]) (◀) (→88, 100, 101) | <b>28</b> | <b>Touch screen</b> (→42) / <b>monitor</b> (→259)   |

**Function buttons [Fn4] to [Fn8] are touch icons.**

They can be displayed by touching the [Fn] tab on the recording screen.

## Attaching the Hand Strap

To prevent dropping, be sure to attach the supplied strap and fit it to your wrist.

Ⓐ Strap eyelet

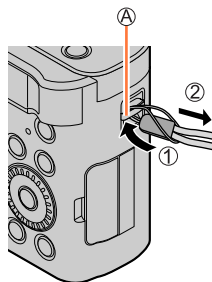

## Charging battery

Use an AC adaptor (supplied/optional/commercially available) and USB connection cable (supplied/commercially available) to charge the battery.

- **Depending on the country or area where the camera was purchased, the AC adaptor or USB connection cable may not be supplied with the camera.**
- **For charging, we recommend using the supplied AC adaptor or the AC adaptor (DMW-AC11: optional).**
- **Always charge before first use! (battery shipped uncharged)**
- **Charge the battery while it is in the camera.**

Camera status	Charge
Turn off	Yes
Turn on	No

- The battery can be charged using a commercially available AC adaptor or USB connection cable.
  - Recommended specifications for AC adaptors (commercially available)
    - Supports DC 5 V / 3 A (15 W) output
    - USB Type-C
  - For charging, use a USB connection cable with an output of 15 W or higher.
- You can also use an AC adaptor of 5 V / 500 mA or higher for charging. However, charging time may be longer than the recommended AC adaptor.
- We do not guarantee operations with all commercially available devices.
- Charge the battery using this camera and the specified method. Using charging methods other than those specified may result in fluid leakage, overheating, combustion, rupturing, etc., and these may cause injury.

### About batteries that you can use with this unit

- The battery that can be used with this unit is DMW-BLG10.

**It has been found that counterfeit battery packs which look very similar to the genuine products are made available to purchase in some markets. Some of these battery packs are not adequately protected with internal protection to meet the requirements of appropriate safety standards. There is a possibility that these battery packs may lead to fire or explosion. Please be advised that we are not liable for any accident or failure occurring as a result of use of a counterfeit battery pack. To ensure that safe products are used we recommend that a genuine Panasonic battery pack is used.**

## Inserting the battery

To charge the battery, insert it into the camera.

### 1 Slide the release lever to the [OPEN] position and open the card/battery door

(A) Release lever

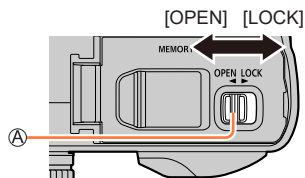

### 2 Insert the battery all the way

- Insert the battery all the way firmly and check that it is locked by lever.

### 3 Close the card/battery door and then slide the release lever to the [LOCK] position

(B) Make sure to insert the battery in the correct orientation.

(C) Lever

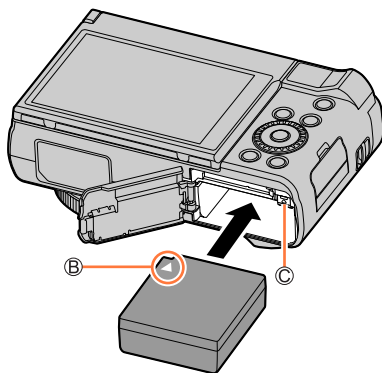

### To remove battery

Move the lever in the card/battery compartment in the direction of the arrow.

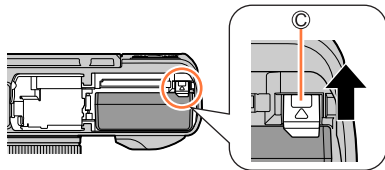

- Always use genuine Panasonic batteries.
- If you use other batteries, we cannot guarantee the quality of this product.
- To remove the battery, turn the camera off and wait until the LUMIX indicator on the screen goes off. (Failure to wait may cause the camera to malfunction and may damage the card or recorded data.)
- Remove battery from camera after use.

## Charging the battery

We recommend charging in a location where the ambient temperature is between 10 °C and 30 °C (50 °F to 86 °F) (same for the battery temperature).

**Insert the battery into the camera.  
Make sure that the camera is turned off.**

The battery can be charged from an outlet or through a PC.

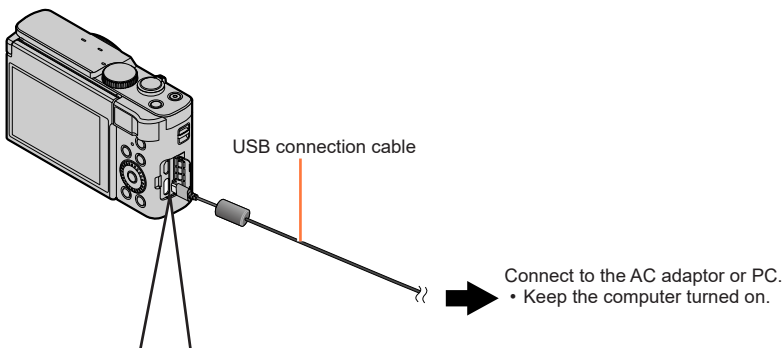

**When charging the camera, connect the USB connection cable to the [USB/CHARGE] socket.**

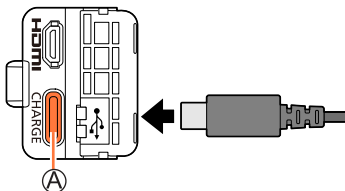

- Ⓐ [USB/CHARGE] socket
- This terminal is located at the bottom.
  - Always check the direction of the socket, and hold the plug straight to insert or remove it. (Inserting these at an angle may cause deformation or malfunction)  
Also, do not insert into the wrong socket. Doing so may cause damage to this unit.

## Charging battery

- If the computer enters sleep mode during charging, charging may be stopped.
- If a notebook computer that is not connected to an electrical outlet is connected to the camera, the battery of the notebook computer will be depleted. Do not leave the camera and notebook connected for a long period of time.
- Always connect the USB connection cable to the USB connector on your computer. Do not connect the USB connection cable to the USB connector of the monitor, keyboard, printer, or USB hub.

## Charging lamp indications

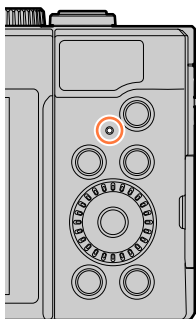
**Charging lamp (Red)**

On: Charging in progress

Off: Charging complete

(After charging stops, disconnect the camera from the electrical outlet or your computer.)

Flashing: Charging error

(For instructions on correcting the problem, refer to [\(→267\)](#).)

## Notes on charging time

### Charging time

When using the AC adaptor (supplied)	Approx. 190 min.
When using the AC adaptor (optional: DMW-AC11)	Approx. 190 min.

- The charging time indicated above is the time required for charging in case when the battery is completely used up. The time required for charging differs depending on conditions of battery usage. Charging takes longer in cases when temperatures are either high or low and when the battery has not been used for a long period of time.
- The time required for charging through the computer varies depending on the power supply capacity of the computer.
- Do not use USB extension cables or USB conversion adaptors.
- The AC adaptor (supplied) and the USB connection cable (supplied) are dedicated accessories of this camera. Do not use them for other devices.
- Remove the battery after use. (The battery will be exhausted if left for a long period of time after being charged.)
- If there is any trouble related to the electrical outlet (i.e. power failure), charging may not complete properly. Disconnect the USB connection cable and reconnect it to the camera.

## Remaining battery

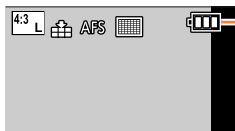

### Remaining battery (only when using battery)



(flashes red)

If the battery mark flashes red, recharge or replace a fully charged battery.

- If the battery indication does not go to  even when charging is complete, the battery may be deteriorating. Try not to use that battery.

### Estimated number of recordable pictures and operating time (DC-ZS99P/DC-ZS99PP/DC-TZ99GD)

Numbers of recordable still pictures are based on CIPA (Camera & Imaging Products Association) standards.

When a Panasonic SDHC memory card and the supplied battery are used.

#### ■ Recording still pictures

Number of recordable pictures	Approx. 380 pictures
Recording time	Approx. 190 min.

#### ■ Recording motion pictures

[Rec Quality]	[FHD/28M/60p]	[4K/100M/30p]
Available recording time	Approx. 100 min.	Approx. 90 min.
Actual available recording time*	Approx. 50 min.	Approx. 45 min.

\* The time you can actually record when repeating actions such as turning the camera on/off and starting/stopping recording.

#### ■ Viewing pictures

Playback time	Approx. 270 min.
---------------	------------------

#### ● The operating times and number of recordable pictures will differ according to the environment and the operating conditions.

For example, in the following cases, the operating times shorten and the number of recordable pictures is reduced.

- In low-temperature environments, such as on ski slopes.
  - When operations such as the flash and zoom are used repeatedly.
- If available battery power is significantly reduced, battery is reaching end of lifespan. Please purchase a new battery.

## Charging battery

### Estimated number of recordable pictures and operating time (DC-TZ99E/DC-TZ99GA/DC-TZ99GH/DC-TZ99GN)

Numbers of recordable still pictures are based on CIPA (Camera & Imaging Products Association) standards.

When a Panasonic SDHC memory card and the supplied battery are used.

#### ■ Recording still pictures

Number of recordable pictures	Approx. 380 pictures
Recording time	Approx. 190 min.

#### ■ Recording motion pictures

[Rec Quality]	[FHD/28M/60p] [FHD/28M/50p]	[4K/100M/30p] [4K/100M/25p]
Available recording time	Approx. 100 min.	Approx. 90 min.
Actual available recording time*	Approx. 50 min.	Approx. 45 min.

\* The time you can actually record when repeating actions such as turning the camera on/off and starting/stopping recording.

#### ■ Viewing pictures

Playback time	Approx. 270 min.
---------------	------------------

#### ● The operating times and number of recordable pictures will differ according to the environment and the operating conditions.

For example, in the following cases, the operating times shorten and the number of recordable pictures is reduced.

- In low-temperature environments, such as on ski slopes.
  - When operations such as the flash and zoom are used repeatedly.
- If available battery power is significantly reduced, battery is reaching end of lifespan. Please purchase a new battery.

## Inserting and removing the card (optional)

- Make sure that the camera is turned off.

### 1 Slide the release lever to the [OPEN] position and open the card/battery door

Ⓐ Release lever

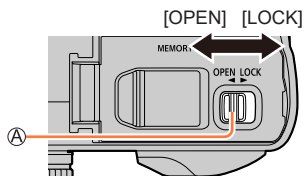

### 2 Insert the card all the way

Ⓑ Do not touch the terminal

- Check the orientation of a card.
- Insert the card all the way firmly until it clicks.

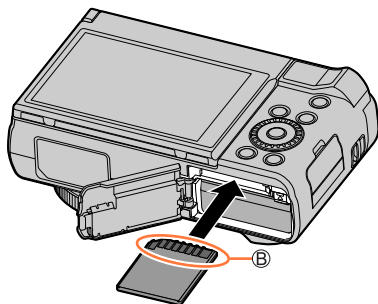

### 3 Close the card/battery door and slide the release lever to the [LOCK] position

#### ■ To remove card

Press the center of the card.

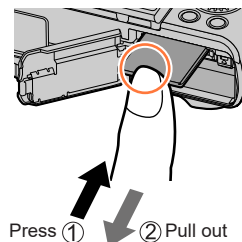

- Keep the memory card out of reach of children to prevent swallowing.
- To remove the card, turn the camera off and wait until the LUMIX indicator on the screen goes off. (Failure to wait may cause the camera to malfunction and may damage the card or recorded data.)

## About the Card

The following SD standard-based cards can be used.

- SD memory card, SDHC memory card, and SDXC memory card are referred to by the generic name of **card** in this document.

**SD memory card/  
SDHC memory card/  
SDXC memory card  
(Maximum 512 GB)**

The camera supports SDHC/SDXC memory cards compliant with UHS Speed Class 3 of the UHS-I standard.

### ■ About motion picture/4K photo recording and speed class ratings

Use a card that meets the following ratings of the SD Speed Class or UHS Speed Class.

- SD Speed Class and UHS Speed Class are the speed standards regarding continuous writing. Confirm the SD speed by checking the card label or other card related materials.

[Rec Quality]	Speed class	Label example
[FHD]/[HD]	Class 4 or higher	CLASS 4, 4
[4K]/[High Speed Video]	UHS Speed Class 3	3
When recording in 4K Photo / [Post Focus]	UHS Speed Class 3	3

### Access to the card

The access indication displays red when pictures are being recorded on the card.



- **Do not perform the following operations during access.**  
The camera may operate incorrectly or the card and recorded images may be damaged.
  - Turn off the camera.
  - Remove the battery or card.
  - Subject the camera to vibration, impacts, or static electricity.
- If you set the write-protect switch to "LOCK", you may not be able to write, delete or format the data or display it by recording date.
- It is recommended that you copy important pictures to your computer (as electromagnetic waves, static electricity, or faults may cause data to be damaged).



## Formatting the card (initialization)

Format the card before recording a picture with this unit.

**Since data cannot be recovered after formatting, make sure to back up necessary data in advance.**

**MENU** →  **[Setup]** → **[Format]**

- Take care not to turn off the camera while formatting is in progress.
- Do not turn off the camera or perform other operations during formatting.
- Always format cards with this camera. Please reformat the card with this camera if it has already been formatted with a computer or another device.

## Estimated recording capacity (number of pictures/recording time)

The number of pictures you can take and the recording time vary in proportion to card capacity (and depending on recording conditions and type of card).

### Recording picture capacity (still pictures)

When **[Aspect Ratio]** is set to **[4:3]** and **[Quality]** is set to **[**

[Picture Size]	16 GB	32 GB	64 GB	128 GB
L (20M)	1450	2910	5810	11510
<b>EX</b> M (10M)	2630	5280	10510	20810
<b>EX</b> S (5M)	4600	9220	17640	34940

When **[Aspect Ratio]** is set to **[4:3]** and **[Quality]** is set to **[**

[Picture Size]	16 GB	32 GB	64 GB	128 GB
L (20M)	450	900	1810	3590
<b>EX</b> M (10M)	520	1050	2110	4180
<b>EX</b> S (5M)	570	1150	2290	4550

- When the number of recordable pictures exceeds 9,999, "9999+" is displayed.

### Recording time capacity (motion pictures) (DC-ZS99P/DC-ZS99PP/DC-TZ99GD)

- The recordable time is the total time of all the motion pictures which have been recorded.

([h], [m] and [s] indicate “hour”, “minute” and “second”.)

[Rec Quality]	16 GB	32 GB	64 GB	128 GB
[4K/100M/30p]	20m00s	41m00s	1h25m	2h45m
[FHD/28M/60p]	1h10m	2h25m	5h00m	9h55m
[FHD/20M/30p]	1h35m	3h15m	6h40m	13h15m
[HD/10M/30p]	3h05m	6h20m	12h45m	25h20m

- MP4 motion pictures with a [Rec Quality] size of [FHD] or [HD]:  
Files are split into smaller motion picture files for recording and playback when the file size exceeds 4 GB. (You can continue to record motion pictures without interruption.)
  - Motion pictures with [Rec Quality] setting of [FHD/28M/60p]:  
Recording stops when the continuous recording time exceeds 29 minutes and 59 seconds.
- MP4 motion pictures with a [Rec Quality] size of [4K]:  
Recording stops when the continuous recording time exceeds 15 minutes.  
When using an SDHC memory card, files are split into smaller motion picture files for recording and playback if the file size exceeds 4 GB. (You can continue to record motion pictures without interruption.)  
If using an SDXC memory card, you can record a motion picture in a single file even if the size is greater than 4 GB.
- **The maximum available continuous recording time is displayed on the screen.**

### Recording time capacity (motion pictures) (DC-TZ99E/DC-TZ99GA/DC-TZ99GH/DC-TZ99GN)

- The recordable time is the total time of all the motion pictures which have been recorded.

([h], [m] and [s] indicate “hour”, “minute” and “second”.)

[Rec Quality]	16 GB	32 GB	64 GB	128 GB
[4K/100M/30p] [4K/100M/25p]	20m00s	41m00s	1h25m	2h45m
[FHD/28M/60p] [FHD/28M/50p]	1h10m	2h25m	5h00m	9h55m
[FHD/20M/30p] [FHD/20M/25p]	1h35m	3h15m	6h40m	13h15m
[HD/10M/30p] [HD/10M/25p]	3h05m	6h20m	12h45m	25h20m

- MP4 motion pictures with a [Rec Quality] size of [FHD] or [HD]:  
Files are split into smaller motion picture files for recording and playback when the file size exceeds 4 GB. (You can continue to record motion pictures without interruption.)
  - Motion pictures with [Rec Quality] setting of [FHD/28M/60p]/[FHD/28M/50p]:  
Recording stops when the continuous recording time exceeds 29 minutes and 59 seconds.
- MP4 motion pictures with a [Rec Quality] size of [4K]:  
Recording stops when the continuous recording time exceeds 15 minutes.  
When using an SDHC memory card, files are split into smaller motion picture files for recording and playback if the file size exceeds 4 GB. (You can continue to record motion pictures without interruption.)  
If using an SDXC memory card, you can record a motion picture in a single file even if the size is greater than 4 GB.
- The maximum available continuous recording time is displayed on the screen.**

## Setting the clock

The clock is not set when the camera is shipped.

### 1 Press the Camera [ON/OFF] button

- If the language select screen is not displayed, proceed to step 4.

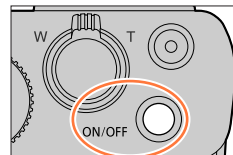

### 2 Press [MENU/SET] while the message is displayed

### 3 Press ▲ ▼ to select the language, and press [MENU/SET]

- The [Please set the clock] message appears.

### 4 Press [MENU/SET]

### 5 Press ◀ ▶ to select the items (year, month, day, hour, minute), and press ▲ ▼ to set

- Ⓐ : Home time
- : Destination time
- Ⓑ Style
- Ⓒ Display order
- Ⓓ Time display format

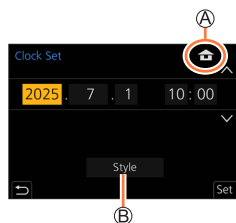

#### ■ To set the display order or time display format

Select [Style] and press [MENU/SET] to display the setting screen for display order and time display format.

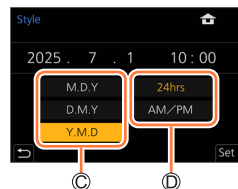

### 6 Press [MENU/SET]

**7** When [The clock setting has been completed.] is displayed, press [MENU/SET]

**8** When [Please set the home area] is displayed, press [MENU/SET]

**9** Press ◀▶ to set your home area and press [MENU/SET]

- Ⓔ City or area name
- Ⓕ Current time
- Ⓖ Difference from GMT (Greenwich Mean Time)

- Time zones may be revised depending on the country or area, so the place name displayed on the screen may not match the actual time zone. Please also refer to the time difference displayed at the bottom of the screen before setting.

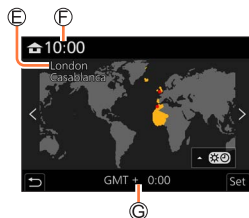

#### ■ Changing time settings

Perform steps **5** and **6** by selecting [Setup] menu → [Clock Set].

- For details about how to set the menu (→45)

## Holding the camera

Hold the camera gently with both hands keeping your arms close to your body while standing with your feet slightly apart.

- To prevent dropping, be sure to attach the supplied strap and fit it to your wrist.
- Do not block the flash, AF Assist Lamp, microphone, or speaker with your fingers or other objects.
- Make sure that the camera does not move at the moment the shutter button is pressed.
- Make sure your footing is stable and there is no danger of colliding with another person or object in the vicinity while taking pictures.

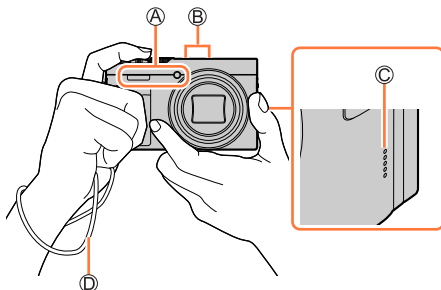

- Ⓐ Flash/AF Assist Lamp
- Ⓑ Microphone
- Ⓒ Speaker
- Ⓓ Hand strap

### ■ About the direction detect function

Still pictures recorded with the camera held vertically can be automatically displayed in portrait orientation during playback. (Only when [Rotate Disp.] is set to [ON].)

- The direction detect function may not operate correctly if pictures are taken with the camera pointing up or down.
- You can set whether or not to record the camera's vertical orientation information during video recording. (→191)

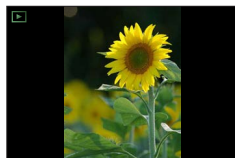

## Adjusting the angle of the monitor

You can adjust the angle of the monitor.

- **Be careful not to catch your finger, etc. in the monitor.**
- **When rotating the angle of the monitor, be careful not to apply too much force. Doing so may cause damage or malfunction.**  
(Open and close with your finger on point (A).)
- When not using this camera, close the monitor completely back to the original position.

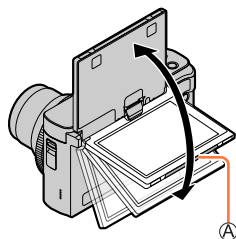

## Recording from a variety of angles

The monitor can be rotated to suit your needs. This is convenient as it allows you to take pictures from various angles by adjusting the monitor.

### Taking pictures of yourself

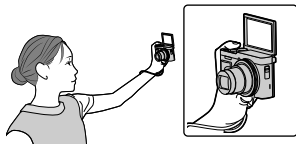

- If you rotate the monitor as shown in the figure, the camera will switch to Self Shot Mode. (→58)

### Taking pictures at low angle

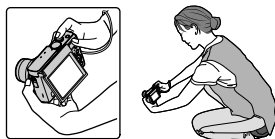

## Basic Operation

### Zoom Lever (Use Zoom)

You can adjust the area of a picture to be taken using the zoom or control ring.

- You can also use the zoom function from the touch panel. (→144)
- For details about zoom types and use, refer to (→141).

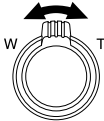
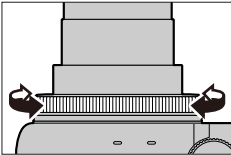
Zoom lever	Control ring*
<p><b>1 Move the zoom lever</b></p> 	<p><b>1 Turn the control ring</b></p>  <p>* You can perform zoom operations by assigning [Zoom] or [Step Zoom] to the control ring. (→51)</p>
<p>T side: Telephoto, Enlarge the subject  W side: Wide-angle, Capture a wider area  Turning angle is large: Zoom speed is high  Turning angle is small: Zoom speed is low</p>	<p>Clockwise: Telephoto, Enlarge the subject  Counterclockwise: Wide-angle, Capture a wider area</p>

- Do not touch the lens barrel during zooming.
- Adjust the focus after adjusting the zoom.
- The camera may make a rattling noise and vibrate when the zoom lever or control ring is operated. This is not a malfunction.

## [Zoom Compose Assist] button (Using the Zoom Compose Assist function)

If you lose the subject while zoomed in, you can make it easier to find the subject again by temporarily decreasing the zoom magnification.

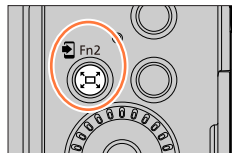

If you lose the subject while zoomed in:

### 1 Press and hold [] ([Zoom Compose Assist]) button

- As you zoom out, a frame indicating the original zoom magnification (angle of view) will appear in the center of the screen. (You cannot change the position of the frame.)



When you find the subject:

### 2 Align the frame with the subject and release your finger from the button

- The camera will return to the original zoom magnification (angle of view).



## ■ Setting how much the camera zooms out

**MENU** →  [Custom] →  [Operation] → [Zoom Compose Assist]

### Settings: [L] / [S]

[L]	The camera zooms out more. (The camera zooms out farther toward the W side than with the [S] setting.)
[S]	The camera zooms out less.

- While using [Zoom Compose Assist], you cannot perform any other zoom operations.
- [Zoom Compose Assist] is not available during recording, or when the camera is set to a function that does not allow zoom operations.

## Shutter button (Taking pictures)

### 1 Press the shutter button halfway (press lightly) to focus on the subject

- Ⓐ Focus display  
(When focus is aligned: illuminated  
When focus is not aligned: flashing)
- Ⓑ Shutter speed
- Ⓒ Aperture value

- The aperture value and shutter speed are displayed. (If the aperture value and shutter speed are shown in red and flashing, you do not have the appropriate exposure, unless you are using the flash.)

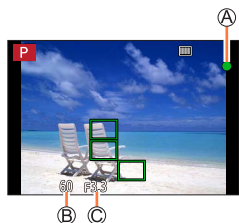

### 2 Press the shutter button fully (push the button all the way), and take the picture



- Pictures can be taken only when the image is correctly focused as long as the [Focus/Release Priority] is set to [FOCUS].
- When [Monitor Display Speed] is set to [ECO 30fps], Digital Zoom is not available.
- Even during menu operation or picture playback, if you press the shutter button halfway, you can instantly set the camera ready for recording.

### Focus range

Focus range is displayed when operating the zoom

- Ⓐ Focus range

The focus range may change gradually depending on the zoom position.



- The focus range is displayed in red when it is not focused after pressing the shutter button halfway.

## Motion picture button (Recording motion pictures)

- 1 Press the motion picture button to start recording
  - Immediately release the motion picture button after pressing it.
- 2 Press the motion picture button again to end recording

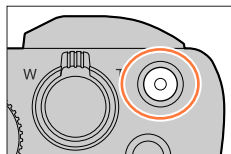

## Mode dial (Select the recording mode)

- 1 Set to the desired recording mode
  - Rotate the mode dial slowly to select the desired mode.

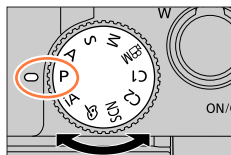

iA	Intelligent Auto Mode (→53)
	Intelligent Auto Plus Mode (→53)
P	Program AE Mode (→64)
A	Aperture-Priority AE Mode (→66)
S	Shutter-Priority AE Mode (→67)
M	Manual Exposure Mode (→68)
	Creative Video Mode (→81)
C1/C2	Custom Mode (→86)
SCN	Scene Guide Mode (→71)
	Creative Control Mode (→75)

## Control ring / Control dial

You can select menu items etc. by rotating the control dial.

You can use the control ring (A)/control dial (B) to change the settings for recording.

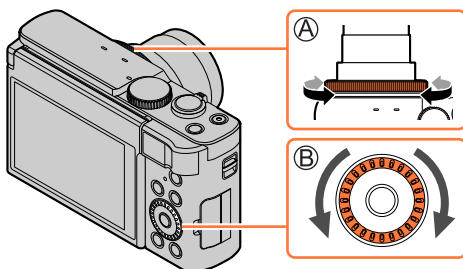

Following are the pre-assigned settings.

Mode dial	Control ring*1	Control dial
iA	Step Zoom	—
P		Program Shift
A		Aperture adjustment
S		Shutter speed adjustment
M	Aperture adjustment*2	Shutter speed adjustment*2
M	Aperture adjustment*3 /  Shutter speed adjustment*3	
SCN	Aperture adjustment*4 /  Shutter speed adjustment*5	
		Picture effects change

\*1 When Manual Focus is set, the control ring is assigned to focus adjustment.

\*2 Press to switch between shutter speed adjustment and aperture adjustment.

\*3 When [Exposure Mode] is set to [A], [S], or [M], you can change the aperture value and shutter speed in the same way as when the mode dial is set to [A], [S], or [M].

\*4 The operation is possible only when the Scene Guide Mode is set to [Appetizing Food].

\*5 The operation is possible only when the Scene Guide Mode is set to [Artistic Nightscape].



The control ring/control dial can be used to change to your preferred settings. (→51)

## Cursor button / [MENU/SET] button (Selecting/setting items)

### Pressing the cursor button:

Selection of items or setting of values etc., is performed.

### Pressing [MENU/SET]:

Confirmation of setting contents, etc., is performed.

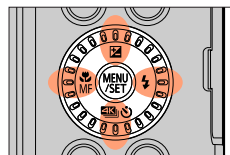

## [DISP.] button (Switching the display information)

### 1 Press [DISP.] button to switch the display

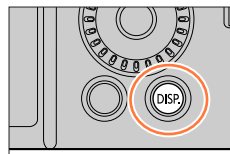

## During recording

You can switch the monitor display method.

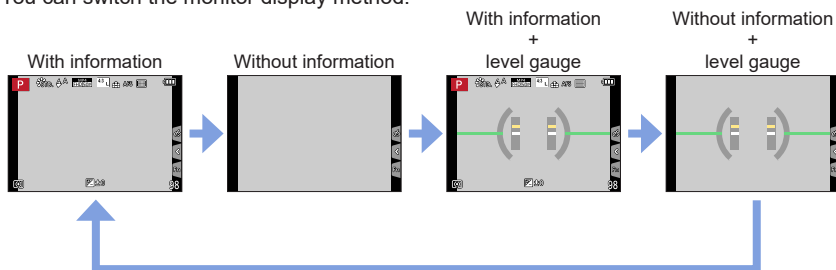

### ■ Using the level gauge

The yellow line indicates the current angle. Correct the angle of the camera so that it matches the white line.

#### Tilting up or down

- In this case, it is facing upward.

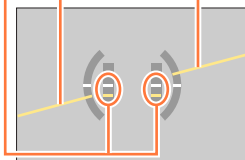
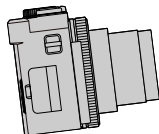

#### Tilting left or right

- In this case, the right side has dropped.

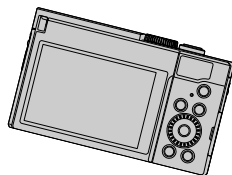

- When the camera is tilted very little or not at all, the level gauge will turn green.

- Even when angle is corrected, there may be an error of about  $\pm 1$  degree.
- The level gauge may not be displayed correctly or the direction detect function may not operate correctly if the pictures are taken with the camera pointing sharply up or down.

### During playback

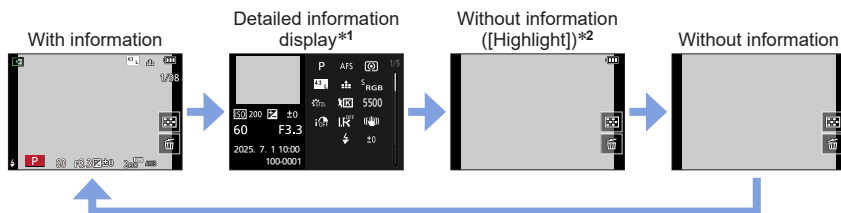

\*1 Press  $\blacktriangle$   $\blacktriangledown$  to switch between the following display modes:

- Detailed information display
- Histogram display
- Photo style display
- White balance display
- Lens information display

\*2 This screen is displayed only when [Highlight] in the [Custom] ([Monitor / Display]) menu is set to [ON].

## Touch screen (Touch operations)

### Touch

To touch and release the touch screen.

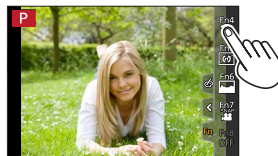

### Drag

To touch and slide your finger across the touch screen.



### Pinch (spread/pinch)

On the touch screen, spread (pinch out) your 2 fingers to zoom in, and pinch (pinch in) your 2 fingers to zoom out.

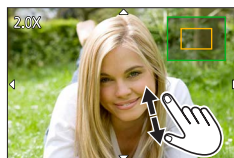

- Touch the screen with the clean and dry finger.
- If you use a commercially available monitor protection sheet, please follow the instructions that accompany the sheet. (Some monitor protection sheets may impair visibility or operability.)
- The touch screen may not function normally in the following cases.
  - When touched by a gloved hand
  - When the touch screen is wet

## Taking pictures using the touch function

### Focusing on the subject at the touched position (Touch AF, Touch Shutter)

Recording mode:   **P** **A** **S** **M**  **SCN** 

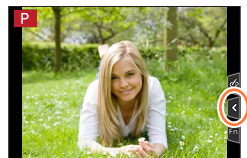

#### 1 Touch []



#### 2 Touch an icon

- The icon switches every time you touch it.



 (Touch AF)	Focuses on the position you touch.*
 (Touch shutter)	Focuses on the touched position before recording takes place.*
 (OFF)	Touch AF and Touch Shutter are disabled.

\*When [Touch AF] in [Touch Settings] of the [Custom] ([Operation]) menu is set to [AF+AE], the focus and brightness are optimized for the touched position. (→99)

#### 3 (When settings other than OFF are selected) Touch the subject

For details on changing the position and size of the AF area when the  (Touch AF) is set, refer to (→96).



- If shooting with the touch shutter fails, the AF area turns red and disappears.

## Matching the brightness to the touched position ([Touch AE])

Recording mode: **[A]** **[Av]** **[P]** **[AS]** **[M]** **[M]** **[SCN]** **[RE]**

When the face of the subject appears dark, you can brighten the screen according to the brightness of the face.

### 1 Touch [**<**]

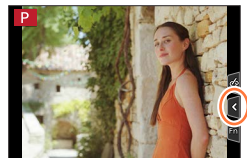

### 2 Touch [**AE**]

- The setting screen for the brightness optimization position is displayed.
- [Metering Mode] is set to [**AE**], which is used exclusively for the [Touch AE].

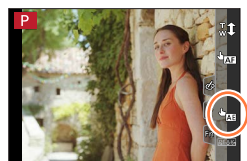

### 3 Touch the subject you want to optimize the brightness for

- Touching [Reset] will bring the brightness optimization position back to the center.



### 4 Touch [Set]

## ■ Canceling the [Touch AE] function

Touch [**AE**]

- This function is not available in the following cases:
  - In Self Shot Mode
  - When using the Digital Zoom
  - When recording with [High Speed Video]
  - When recording using [4K Live Cropping]
  - When [Touch AF] in [Touch Settings] of the [Custom] ([Operation]) menu has been set to [AF+AE]

## Setting the menu

Menu settings can be made either by button or touch operation.

### 1 Press [MENU/SET] to bring up the menu







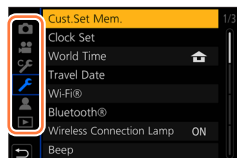

### 2 Switch the menu type

- ① Press ◀
- ② Press ▲▼ to select a tab such as [🔧]
- ③ Press [MENU/SET]

— With touch screen operations —

Touch a tab, such as [🔧]



 [Rec] (→167)	You can perform settings for the aspect ratio, number of pixels, 4K Photo, etc.
 [Motion Picture] (→179)	You can select the picture quality and other settings.
 [Custom] (→181)	Operation of the unit, such as displaying of the screen and button operations, can be set up according to your preferences.
 [Setup] (→195)	You can perform settings that make usage more convenient, such as the changing the clock settings and beep tone. You can also perform Wi-Fi/Bluetooth function-related settings.
 [My Menu] (→205)	You can register frequently used menus.
 [Playback] (→206)	You can perform settings for playback and editing pictures.

- Menus to be displayed in each recording mode (→166)

## Setting the menu

### 3 Press ▲▼ to select the menu item and press [MENU/SET]

- You can switch to the next page by rotating the zoom lever.

#### With touch screen operations

##### Touch the menu item

- You can switch pages by touching (A) on the right side of the display.

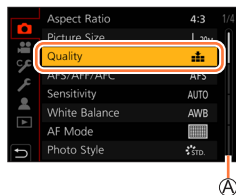

### 4 Press ▲▼ to select the setting and press [MENU/SET]

- The setting methods vary depending on the menu item.

#### With touch screen operations

##### Touch the setting to set

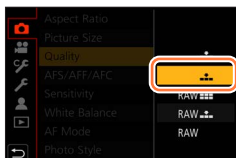

### 5 Press [↵] button repeatedly until the recording or playback screen reappears

- The menu screen can also be exited by pressing the shutter button halfway.

#### With touch screen operations

##### Touch [↵]



- You can display an explanation on the menu by pressing the [DISP.] button while you select a menu item or setting.
- The menu items that cannot be set are grayed out. In some setting conditions, the reason the setting is disabled is displayed when you press [MENU/SET] if you select a grayed-out menu item.



- The operations such as selecting menu items can also be made by rotating the control dial.

## Calling frequently-used menus instantly (Quick Menu)

You can easily call some of the menu items and set them during recording.

### 1 Press [Q.MENU] button

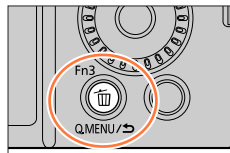

### 2 Rotate the control dial to select a menu item, and press ▼ or ▲

- The menu item can also be selected by pressing ◀▶.

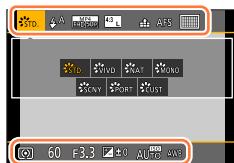

### 3 Rotate the control dial to select the setting

- The setting can also be selected with ◀▶.

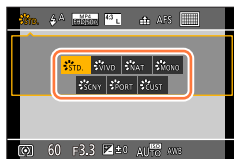

### 4 Press [Q.MENU] button to close the Quick menu

- Some items or settings cannot be selected depending on the mode or display style the camera is in.

## Assigning frequently used functions to the buttons

(Function buttons)

You can assign frequently-used functions to particular buttons ([Fn1] - [Fn3]) or icons displayed on the screen ([Fn4] - [Fn8]).

### 1 Set the menu

**MENU** →  [Custom] →  [Operation] → [Fn Button Set]

Settings: [Setting in REC mode] / [Setting in PLAY mode]

### 2 Press ▲ ▼ to select the function button you want to assign a function to and press [MENU/SET]

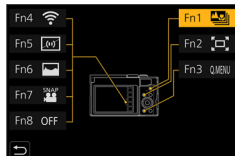

### 3 Press ▲ ▼ to select the function you want to assign and press [MENU/SET]

- For details on the functions that can be assigned in [Setting in REC mode], refer to (→49).
- For details on the functions that can be assigned in [Setting in PLAY mode], refer to (→50).

#### ■ Rapidly assigning functions

The screen displayed in Step 3 can be displayed by holding a function button ([Fn1] to [Fn3]) for 2 seconds. (Depending on the registered function or displayed screen, it may not be possible to display the assignment screen.)

- Certain functions cannot be assigned to some function buttons.
- The function assigned to the function button may not work in some modes or on some display screens.

## Assigning frequently used functions to the buttons (Function buttons)

## Using the function buttons during recording

Press the function button to use the assigned function.

## Using function buttons with touch operations

- ① Touch [Fn]
- ② Touch [Fn4], [Fn5], [Fn6], [Fn7] or [Fn8]

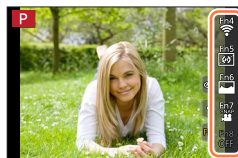

## Functions that can be assigned in [Setting in REC mode]

- |  |  |  |
|--|--|--|
| <ul style="list-style-type: none"> <li>• [4K Photo Mode]:</li> <li>• [Post Focus]: [Fn1]*1</li> <li>• [Wi-Fi]: [Fn4]*1</li> <li>• [Q.MENU]: [Fn3]*1</li> <li>• [Video Record]</li> <li>• [AF/AE LOCK]</li> <li>• [AF-ON]</li> <li>• [Preview]</li> <li>• [One Push AE]</li> <li>• [Touch AE]</li> <li>• [Level Gauge]: [Fn5]*1</li> <li>• [Focus Area Set]</li> <li>• [Operation Lock]</li> <li>• [Photo Style]</li> <li>• [Filter Effect]</li> <li>• [Aspect Ratio]</li> <li>• [Picture Size]</li> <li>• [Quality]</li> </ul> | <ul style="list-style-type: none"> <li>• [Sensitivity]</li> <li>• [White Balance]</li> <li>• [AF Mode]</li> <li>• [AFS/AFF/AFC]</li> <li>• [Metering Mode]</li> <li>• [Bracket]</li> <li>• [i.Dynamic]</li> <li>• [i.Resolution]</li> <li>• [Min. Shtr Speed]</li> <li>• [HDR]</li> <li>• [Shutter Type]</li> <li>• [Flash Adjust.]</li> <li>• [i.Zoom]</li> <li>• [Digital Zoom]</li> <li>• [Stabilizer]</li> <li>• [4K Live Cropping]</li> <li>• [Snap Movie]: [Fn7]*1</li> <li>• [Motion Pic. Rec Quality]</li> </ul> | <ul style="list-style-type: none"> <li>• [Silent Mode]</li> <li>• [Peaking]</li> <li>• [Histogram]: [Fn6]*1</li> <li>• [Guide Line]</li> <li>• [Zebra Pattern]</li> <li>• [Monochrome Live View]</li> <li>• [Rec Area]</li> <li>• [Zoom lever]</li> <li>• [Zoom Compose Assist]: [Fn2]*1</li> <li>• [Exposure Comp.]</li> <li>• [Flash Mode]</li> <li>• [Focus Mode]</li> <li>• [Drive Mode]</li> <li>• [Rec / Playback Switch]</li> <li>• [Off]*2: [Fn8]*1</li> </ul> |
|--|--|--|

\*1 Function button settings at the time of purchase.

\*2 No function is assigned to function buttons.

## Assigning frequently used functions to the buttons (Function buttons)

- When [Video Record] is assigned to the function button, you can start and stop recording motion pictures in the same way as pressing the motion picture button.
- When [Focus Area Set] is assigned to the function button, you can display the AF area or the MF Assist position setting screen.
- When [Operation Lock] is assigned to the function button, you can disable the operations that were set using [Operation Lock Setting] in the [Custom] ([Operation]) menu. To cancel the lock, press the function button to which [Operation Lock] is assigned again.
- When [Rec / Playback Switch] is assigned to the function button, you can switch between recording mode and playback mode.
- To restore the default function button settings, select [Restore to Default].
- If the screen displays (A) or similar, the displayed operation will be performed instead of the function assigned to function buttons by [Fn Button Set].

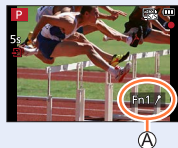

## Using the function buttons during playback

You can directly set an assigned function to a selected image by pressing the function button during playback.

Example: When [Fn2] is set to [Rating★3]

- 1 Press ◀▶ to select the picture
- 2 Press [Fn2] button, and then set the picture as [Rating★3]

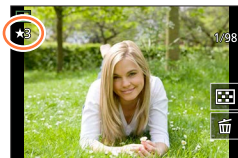

## Functions that can be assigned in [Setting in PLAY mode]

- The following functions can be assigned to the button [Fn1] or [Fn2].

- |   |   |   |
|---|---|---|
| <ul style="list-style-type: none"> <li>● [Wi-Fi]: [Fn1]*1</li> <li>● [Rec / Playback Switch]</li> <li>● [Send Image (Smartphone)]: [Fn2]*1</li> <li>● [4K PHOTO Play]</li> <li>● [Delete Single]</li> </ul> | <ul style="list-style-type: none"> <li>● [Protect]</li> <li>● [Rating★1]</li> <li>● [Rating★2]</li> <li>● [Rating★3]</li> <li>● [Rating★4]</li> </ul> | <ul style="list-style-type: none"> <li>● [Rating★5]</li> <li>● [RAW Processing]</li> <li>● [4K PHOTO Bulk Saving]</li> <li>● [Off]*2</li> </ul> |
|---|---|---|

\*1 Function button settings at the time of purchase.

\*2 No function is assigned to function buttons.

- If you assign [4K PHOTO Play], a screen will be displayed, allowing you to select the pictures to be extracted from a 4K burst file and saved.
- To restore the default function button settings, select [Restore to Default].

## Changing the settings assigned to the control ring/ control dial

Recording mode: **P** **A** **S** **M**

Changes the settings assigned to the control ring/control dial.

**MENU** → **[Custom]** → **[Operation]** → **[Ring/Dial Set]**

Settings: (control ring) / (control dial)

### 1 Use **▲ ▼** to select the setting and press **[MENU/SET]**

<b>[DEFLT]</b> [Normal]	[Photo Style]
[Zoom]*	[Filter Effect]
[Step Zoom]*	[Aspect Ratio]
[Exposure Comp.]	[i.Dynamic]
[Sensitivity]	<b>I.R</b> [i.Resolution]
[White Balance]	[Flash Mode]
[AF Mode]	[Flash Adjust.]
[Focus Mode]	<b>[OFF]</b> [Not Set]*
[Drive Mode]	

\* Items that can only be set to the control ring

- To return to the default setting, select [Normal].
- If you do not use the control ring, select [Not Set].

- The assigned function setting applies to all the recording modes.  
However, the assigned function may not operate when combined with certain recording mode.

## Entering Text

Follow the steps below when the text entry screen is displayed.

### 1 Use ▲▼◀▶ to select characters

### 2 Press [MENU/SET] several times until the desired character is displayed

- [ ]: Enter a blank.

#### ■ To change the character type

- Press [DISP.] button
- Use ▲▼◀▶ to select [ ] and press [MENU/SET]

#### ■ To continue entering characters

- Use ▲▼◀▶ to select [ ] and press [MENU/SET]
- Move the zoom lever toward T side
- Rotate the control dial clockwise.

#### ■ To edit text

- ① Use ▲▼◀▶ to select [ ] [ ] and press [MENU/SET]. Then, move the cursor to the text to edit
  - You can also use the zoom lever or control dial to reposition the cursor.
- ② Use ▲▼◀▶ to select [Delete] and press [MENU/SET]
- ③ Use ▲▼◀▶ to select the correct text, and press [MENU/SET]



### 3 When you are finished entering text, use ▲▼◀▶ to select [Set] and press [MENU/SET]

- A maximum of 30 characters can be entered (maximum of 9 characters when setting names in [Face Recog.]).
- A maximum of 15 characters can be entered for [ \ ], [ [ ], [ ] ], [ • ] and [ — ] (maximum of 6 characters when setting names in [Face Recog.]).

## Taking pictures with automatic settings

(Intelligent Auto Mode)

Recording mode:  

This mode is recommended for those who want to point and shoot as the camera optimizes settings to match the subject and recording environment.

**1 Set mode dial to [iA]**

- At the time of purchase, the mode is set to Intelligent Auto Mode.

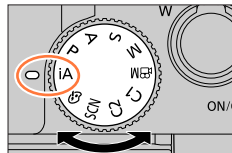
**2 Point the camera at the subject**

- When the camera identifies the optimal scene, it displays the icon for each scene. (Automatic Scene Detection)

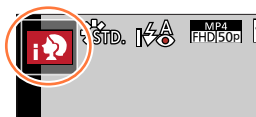
**Switching between Intelligent Auto Plus Mode and Intelligent Auto Mode**



**MENU** →  /  [Intelligent Auto] → [Intelligent Auto Mode]

Settings:  (Intelligent Auto Mode) /  (Intelligent Auto Plus Mode)





It is also possible to display the selection screen by touching the Recording mode icon in recording screen.



 allows you to adjust some settings such as the brightness and color tone while also using  for other settings so that you can record pictures more suited to your preferences.

(○: Available, -: Not available)

	 Intelligent Auto Plus Mode	 Intelligent Auto Mode
Setting the color tone	○	-
Setting the brightness (exposure)	○	-
Defocus control function	○	-
Menus that can be set	Many	Few

## Taking pictures with automatic settings (Intelligent Auto Mode)

## Auto Focus, Face/Eye Detection, and Face Recognition

[AF Mode] is automatically set to [i:👤]. If you touch the subject, the camera switches to [i:👤] and the AF tracking function starts operating.

- You can also switch to [i:👤] by pressing [MENU/SET], going to the [Rec] menu, then going to the [AF Mode] menu and selecting [i:👤] (tracking). Align the AF tracking area with the subject and press the shutter button halfway to operate the AF tracking function.
- When [Face Recog.] is set to [ON] and if the camera recognizes a face similar to a registered face, [R] is displayed on the upper right corner of the [i:👤], [i:👤], and [i:👤] icons.











## Flash

When ▶ is pressed and [i:🔦] (auto) selected, the camera will automatically be set to [i:🔦], [i:🔦] (Auto/Red-Eye Reduction), [i:🔦], or [i:🔦], depending on the type of subject and brightness.







- When [i:🔦] or [i:🔦] is selected, the shutter speed is reduced.

## Automatic Scene Detection

## When taking pictures

 [i-Portrait]	 [i-Scenery]	 [i-Macro]
 [i-Night Portrait]* <sup>1</sup>	 [i-Night Scenery]	 [i-Handheld Night Shot]* <sup>2</sup>
 [i-Food]	 [i-Baby]* <sup>3</sup>	 [i-Sunset]
 /  When scene does not correspond to any of the above		

## When recording motion pictures

 [i-Portrait]	 [i-Scenery]	 [i-Low Light]	 [i-Macro]
 /  When scene does not correspond to any of the above			

\*<sup>1</sup> Displayed only when using flash.

\*<sup>2</sup> When [i-Handheld Night Shot] is [ON].

\*<sup>3</sup> When children (that are registered in the camera with Face Recognition) under 3 years old are recognized.

## Taking pictures with automatic settings (Intelligent Auto Mode)

- When the camera identifies [iA] as the optimal scene and if the camera determines that jitter is reduced by the use of a tripod or by other means, a shutter speed that is slower than usual is selected. After pressing the shutter button, do not move the camera while recording.
  - When recording 4K photos or when recording using [Post Focus], Scene Detection works the same way as when recording motion pictures.
- Depending on recording conditions, different scene types may be determined for the same subject.



## About Backlight Compensation

Backlight compensation is automatically activated in Intelligent Auto Plus Mode or Intelligent Auto Mode. Backlight is a condition where a light shines from behind a subject. When there is a backlight, the subject appears darker and the camera will automatically attempt to correct it by increasing the brightness of the picture.

## [Intelligent Auto] menu

## Taking pictures using a handheld camera ([iHandheld Night Shot])

Recording mode:  

If a night scene is detected automatically while the unit is being handheld, [iHandheld Night Shot] can record a still picture with less jitter and less noise without using a tripod by combining a burst of pictures.

**MENU** →  /  [Intelligent Auto] → [iHandheld Night Shot]

Settings: [ON] / [OFF]

- The angle of view becomes narrow slightly.
- After the shutter button has been pressed, do not move the camera during the burst operation.
- The flash is fixed to the [☺] (Forced Flash Off) setting.
- This function will not work for still pictures while motion pictures are being recorded.
- This function is not available in the following cases:
  - In Self Shot Mode
  - When using [Burst]
  - When recording 4K photos
  - When recording using [Post Focus]
  - When recording using [Bracket]
  - When [Quality] is set to [RAW.iii], [RAW.ii] or [RAW]
  - When using [Time Lapse Shot]
  - When [Auto Shooting] of [Stop Motion Animation] is set to [ON]

## Taking pictures with automatic settings (Intelligent Auto Mode)

## Combining pictures into a single still picture with rich gradation ([iHDR])

Recording mode: 

When there is, for example, strong contrast between the background and the subject, [iHDR] records multiple still pictures with differing exposures and combines them to create a single still picture rich in gradation.

[iHDR] is activated when required. When activated, [iHDR] will be displayed on the screen.

**MENU** →  **[Intelligent Auto]** → **[iHDR]**

Settings: **[ON]** / **[OFF]**

- The angle of view becomes narrow slightly.
- After the shutter button has been pressed, do not move the camera during the burst operation.
- Since a burst of still pictures are combined after they have been recorded, it will be a few moments before you can record another picture.
- In the case of composition from a burst, afterimages may appear if the subject was moving.
- This function will not work for still pictures while motion pictures are being recorded.
- This function is not available in the following cases:
  - In Self Shot Mode
  - When recording using the flash
  - When using [Burst]
  - When recording 4K photos
  - When recording using [Post Focus]
  - When recording using [Bracket]
  - When [Quality] is set to [RAW:⬆️], [RAW:⬆️] or [RAW]
  - When using [Time Lapse Shot]
  - When [Auto Shooting] of [Stop Motion Animation] is set to [ON]

## Setting coloring

Recording mode: 

**1** Press  button (◀) to display the setting screen

**2** Rotate the control dial to adjust color

- Press [MENU/SET] to return to the recording screen.
- The color setting will return to the default level (center point) when this unit is turned off or the camera is switched to another Recording mode.
- With touch screen operations (→57)



## Taking pictures with automatic settings (Intelligent Auto Mode)

## Setting brightness (exposure)/blurriness of the background (Defocus control function)

Recording mode: 

### 1 Press **▲** to display the setting screen

- The brightness (exposure) operation screen is displayed. Press [Fn1] to operate the defocus control, and then press it again to finish the operation.

### 2 Rotate the control dial to set

- Press [MENU/SET] to return to the recording screen.

#### When setting the brightness (exposure)

- You can change the setting content on the exposure compensation screen from [Exposure Comp. Disp. Setting] in the [Custom] ([Operation]) menu. ([→185](#))

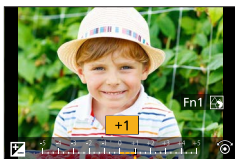





#### When setting the background defocusing

- Pressing [Fn2] button on the blurriness setting screen will cancel the setting.
- Auto Focus Mode is set to . The position of the AF area can be set by touching the screen. (Its size cannot be changed)



### ■ With touch screen operations

- Touch 
- Touch the item you want to set
  - : Coloring
  - : Degree of defocusing
  - : Brightness
- Drag the slide bar or exposure meter to set
  - Press [MENU/SET] to return to the recording screen.



## Taking Pictures of Yourself [Self Shot]

Recording mode:   **P** **A** **S** **M**   

If you rotate the monitor, Self Shot Mode is activated. You can easily take pictures of yourself while looking at the screen.



### In Self Shot Mode...

- Deciding on a composition is easier because recording is performed while looking at the screen.
- Pictures with different poses and facial expressions can be taken at once by increasing the number of pictures to be recorded.
- Automatically enables the touch operation.
- Settings for the respective Recording Modes are maintained, except for the recording settings for Self Shot Mode.

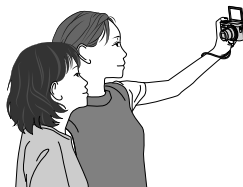

### 1 Rotate the monitor as shown in the figure



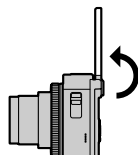



- When you rotate the monitor, a mirror image will be displayed on the monitor.

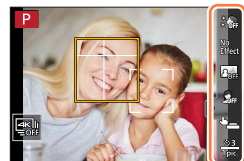

## Taking Pictures of Yourself [Self Shot]

## 2 Touch the item







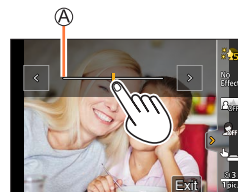

 OFF ((Soft Skin))	Makes people's faces look brighter and their skin tones look softer.
No Effect ((Filter Select))	Add a picture effect (filter) appropriate to [Self Shot].
 OFF ((Background Control))	Changes the degree of defocusing for the background of detected faces. [  ] (Defocus): Defocuses the background of detected faces. (Faces further from the camera, however, will be defocused in the background.) [  ] (Clear): Records faces and the background with clarity.
 ((Slimming Mode))	Makes people look slimmer.
 ((Shutter))	Sets the way the shutter is released.
 3 / 1pic. ((Countdown)]/ ([Shots]))	Set the number of seconds before recording ([Countdown]) and the number of consecutive shots ([Shots]).

## 3 Touch the slide bar

- You can set it to "Off" or a value in the range [1] to [10]. If you select the left edge of the slide bar (A), it will be set to "Off".
- In the case of [Filter Select], [Background Control], [Shutter], or [Shots], select from the icons.



[Filter Select]	[No Effect] (No effect), [EXPS] (Expressive), [RETR] (Retro), [HKEY] (High key), [MONO] (Monochrome), [TOY] (Toy effect)
[Background Control]	[  ] (Off), [  ] (Defocus), [  ] (Clear)
[Shutter]	[  ] (Shutter button only), [  ] (Touch), [  ] (Buddy), [  ] (Face)
[Shots]	[1pic.] (1 pic.), [2pic.] (2 pic.), [3pic.] (3 pic.), [4pic.] (4 pic.)

#### 4 Touch [Exit]

#### 5 Decide on your poses while looking at the monitor

- The AF area is displayed around the subject's face by the Face/Eye Detection function. (If [👤] in AF Mode is not available with the current Recording Mode, an available focus setting for each Recording Mode will be used.)

#### 6 Press the shutter button halfway to focus and then press it fully to take the picture

- **Look at the lens when recording.**
- Countdown starts, and recording takes place when it ends. If multiple pictures are set to be recorded, the recording continues until the set number is reached.
- For information on how to start taking a picture using [Shutter], refer to (→61).

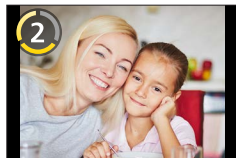

### Changing the way the shutter is released

In [Shutter], you can select the way you start recording without pressing the shutter button.

We recommend that you avoid using the shutter button when, for example, jitter occurs during shutter operation.

#### ■ [] (Touch)

Focuses on the touched position before recording takes place.

#### ■ [] (Buddy)

The shutter is released when two faces detected by the Face/Eye Detection function move closer to each other.

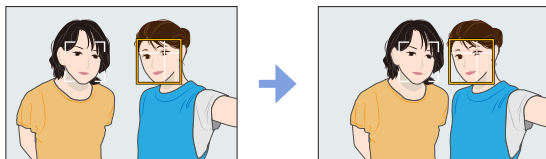

#### ① Display two Face/Eye Detection frames

- When [] (Buddy) is selected, even if several subjects are present, Face/Eye Detection detects only a maximum of two faces.

#### ② The shutter is released when the two frames come within a certain distance of each other

#### ■ [] (Face)

The shutter is released when a face detected by the Face/Eye Detection function is covered with a hand or other object and then detected again.

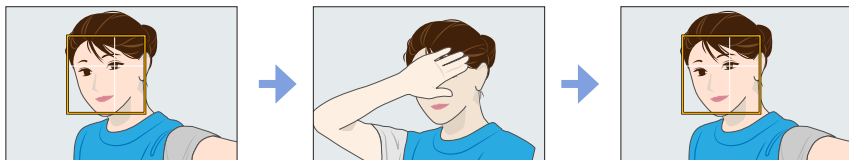

#### ① Display the yellow frame of Face/Eye Detection

#### ② Cover your face with your hand or other object so that the yellow frame disappears for a moment

#### ③ When you move your hand away and the yellow frame appears, the shutter is released

- You can start recording with the shutter button regardless of the [Shutter] setting.

## Taking pictures of yourself in 4K Photo Mode (4K Selfie)

You can switch to 4K Photo Mode and take pictures of yourself.

### 1 Rotate the monitor to enable Self Shot Mode

### 2 Touch

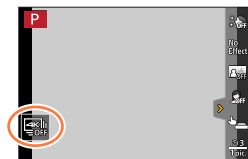

### 3 Select and touch the recording method

- In Self Shot Mode, you can take pictures with [4K Burst (Wide-angle)], a setting that allows you to include a wider background.  
(In modes other than Self Shot Mode, the setting will switch to [4K Burst].)

  
[4K Burst  
(Wide-angle)]

**A 4K Photo Mode for taking selfies with an angle of view wider than that of [4K Burst]**

Burst speed: 15 pictures/second  
Audio recording: Not available



- For information about other types of 4K Photo Mode and the recording methods for 4K Photo Mode, etc., refer to ([→114 - 124](#))

### 4 Decide on your poses while looking at the monitor

#### ■ When [4K Burst (Wide-angle)] is selected

- Press the shutter button halfway
- Press and hold the shutter button fully for as long as you want to perform recording

- Ⓐ Press and hold  
Ⓑ Recording is performed

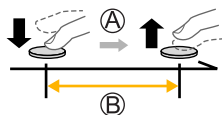



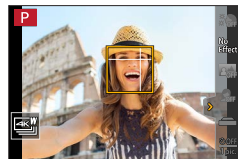



- Recording will start approximately 0.5 seconds after you press the shutter button fully. Therefore, press the button fully slightly in advance.
- [Continuous AF] does not work during recording. The focus is fixed in the first picture.
- If you stop recording burst pictures too soon, the camera may continue recording until a certain time.



- When recording 4K photos, the angle of view becomes narrower. (Except when recording with [4K Burst (Wide-angle)])
- For 4K photo recording, only [Filter Select] can be set.

## Taking Pictures of Yourself [Self Shot]

- If you set [Self Shot] to [OFF], the mode will not switch to Self Shot Mode even if you rotate the monitor.
- Be careful not to look at the light from the flash and the AF Assist Lamp directly.
- We recommend setting the zoom position to Wide when using Self Shot Mode.
- When the [Soft Skin] is set
  - If you set the strength of the effect to [2] or greater, the recording screen display will be more delayed than normal like a frame dropping. Also, when you record, it will require some time to process the image before the next shot.
  - The smoothing effect is applied to the part that has a similar tone to the complexion of a subject, as well.
  - This mode may not be effective under insufficient lighting.
- When [Background Control] is set to  (Defocus), the recording screen display will be more delayed than normal like a frame dropping. Also, when you record, it will require some time to process the image before the next shot.
- If the lighting is insufficient when [Background Control] is set to  (Clear), you may not be able to take pictures as desired.
- This function is not available in the following cases:
  - During motion picture recording
  - When using [Time Lapse Shot]
  - When using [Stop Motion Animation]
- You cannot use [Soft Skin] and a  (Defocus) setting of [Background Control] when using one of the following settings:
  - [Glistening Water], [Clear Nightscape], [Cool Night Sky], [Warm Glowing Nightscape], [Artistic Nightscape], [Glittering Illuminations], [Handheld Night Shot], [Soft Image of a Flower], [Appetizing Food], [Cute Dessert] (Scene Guide Mode)
  - Creative Control Mode
  - In Manual Focus
- You cannot use a [Background Control] setting of  (Clear) when using one of the following settings:
  - Any mode for Scene Guide Mode other than [Silky Skin]/[Monochrome]
  - Aperture-Priority AE Mode
  - Shutter-Priority AE Mode
  - Manual Exposure Mode
  - Creative Control Mode
-  (Buddy) and  (Face) are not available in the following cases:
  - Recording Modes which do not allow setting to  of AF Mode (→91)
  - In Manual Focus

## Taking pictures after automatically setting the aperture value and shutter speed (Program AE Mode)

Recording mode: **[P]**

Take pictures using automatic aperture values and shutter speed settings in accordance with the brightness of a subject.

### 1 Set mode dial to [P]

### 2 Press the shutter button halfway and display the aperture value and shutter speed value on the screen

- Ⓐ Shutter speed
- Ⓑ Aperture value

- If the aperture value and shutter speed flash red, you do not have the correct exposure.

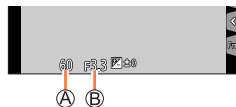

## About Program Shift

The function for maintaining the same exposure (brightness) while changing the aperture value and shutter speed combination is called "Program Shift". You can use "Program Shift" to take pictures by adjusting the aperture value and shutter speed even in Program AE Mode.

### Preparation

Set [Flash Mode] to **[]** (Forced Flash Off). (→145)

### 1 Press the shutter button halfway and display the aperture value and shutter speed value on the screen

- If the aperture value and shutter speed flash red, you do not have the correct exposure.

### 2 While the numeric values are displayed (approximately 10 seconds), rotate the control dial to change the values using Program Shift

- Ⓐ Program Shift indication
- Ⓑ Shutter speed
- Ⓒ Aperture value

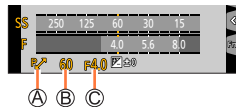

- The operation can also be performed by rotating the control ring.
- To cancel Program Shift, either turn off the camera or rotate the control dial until the Program Shift indication turns off.
- Program Shift can easily be canceled by setting a function button to [One Push AE]. (→48, 70)

## Taking pictures after automatically setting the aperture value and shutter speed (Program AE Mode)

- Program Shift cannot be used in the following cases:
  - When recording using the flash
  - When recording 4K photos
  - When recording using [Post Focus]
  - When ISO sensitivity is set to [ISO]

## Taking pictures by setting the aperture value and shutter speed

Recording mode: **[A][S][M]**

- The effect of the aperture value and shutter speed you have set is not applied to the recording screen. To check the effect on the recording screen, use Preview Mode. (→69)
- The brightness of the screen may vary from the actual pictures recorded. Check the brightness of pictures using the playback screen.
- When you adjust the aperture value and shutter speed, an exposure meter is displayed. If aperture and shutter speed are shown in red, you do not have appropriate exposure.
- If the correct exposure is not achieved when you press the shutter button halfway, the numeric values of the aperture and shutter speed are displayed in flashing red.

### Taking pictures by setting the aperture value (Aperture-Priority AE Mode)

When you set the aperture value, the camera automatically optimizes the shutter speed for the brightness of the subject.

#### 1 Set mode dial to [A]

#### 2 Rotate the control dial to set the aperture value

- The operation can also be performed by rotating the control ring.

- Ⓐ Aperture value
- Ⓑ Exposure meter

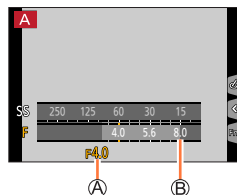

Aperture values that can be set*1	Shutter speed set (seconds)
F3.3 - F8.0	4*2 - 1/2000 (When the mechanical shutter is used) 1*2 - 1/16000 (When the electronic shutter is used)

\*1 You may not be able to select some values depending on zoom position.

\*2 Varies depending on the setting of ISO sensitivity.

## Taking pictures by setting the aperture value and shutter speed

## Taking pictures by setting the shutter speed (Shutter-Priority AE Mode)

When you set the shutter speed, the camera automatically optimizes the aperture value for the brightness of the subject.

### 1 Set mode dial to [S]

### 2 Rotate the control dial to set the shutter speed

- The operation can also be performed by rotating the control ring.

- Ⓐ Shutter speed
- Ⓑ Exposure meter

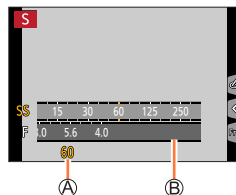

Shutter speeds that can be set (seconds)	Aperture value set
4* - 1/2000 (When the mechanical shutter is used)	F3.3 - F8.0
1* - 1/16000 (When the electronic shutter is used)	

\* Varies depending on the setting of ISO sensitivity.

## Taking pictures by setting the aperture value and shutter speed

## Taking pictures by setting the aperture value and shutter speed (Manual Exposure Mode)

Determine the exposure by manually setting the aperture value and the shutter speed.

### 1 Set mode dial to [M]

### 2 Turn the control ring to set the aperture value, and turn the control dial to set the shutter speed

- You can switch the setting operation of control ring and control dial by pressing ▲.

- Ⓐ Shutter speed
- Ⓑ Aperture value
- Ⓒ Manual Exposure Assist
- Ⓓ Exposure meter

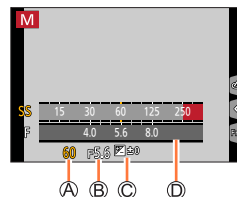

Aperture values that can be set*1	Shutter speeds that can be set (seconds)
F3.3 - F8.0	4*2 - 1/2000 (When the mechanical shutter is used) 1*2 - 1/16000 (When the electronic shutter is used)

\*1 You may not be able to select some values depending on zoom position.

\*2 Varies depending on the setting of ISO sensitivity.



### Optimizing the ISO sensitivity for the aperture value and shutter speed

When the ISO sensitivity is set to [AUTO], the camera sets the ISO sensitivity automatically so that the exposure will be appropriate for the aperture value and shutter speed.

- Depending on recording conditions, an appropriate exposure may not be set or the ISO sensitivity may become higher.



### Manual exposure assist (estimate)

	Shows pictures with standard brightness (appropriate exposure).
	Shows brighter pictures. For the appropriate exposure, either use a faster shutter speed or increase aperture value.
	Shows darker pictures. For the appropriate exposure, either use a slower shutter speed or reduce aperture value.

## Taking pictures by setting the aperture value and shutter speed

## Checking the effects of the aperture value and shutter speed (Preview Mode)

Recording mode:

- **Checking the effect of the selected aperture value:** This enables you to check the depth of field (focus range) by physically narrowing the lens aperture blades to the aperture value used for the actual recording.
- **Checking the effect of the selected shutter speed:** This allows you to check motion in a scene by displaying the screen at the shutter speed used for the actual recording.

### Preparations

Assign [Preview] to the function button (→48)

The following step is an example of assigning [Preview] to the [Fn3] button.

### 1 Press the [Fn3] button to switch the confirmation screen

- Every time you press the [Fn3] button, the screen switches.

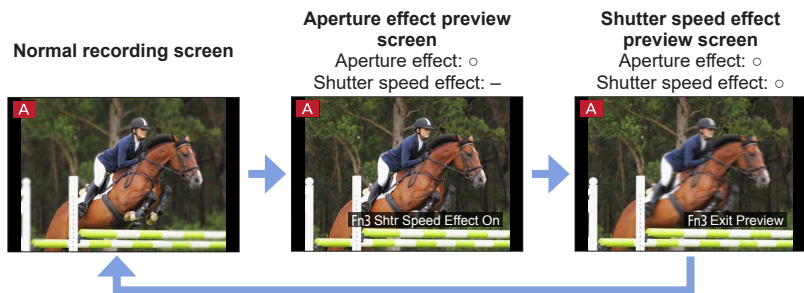

### Depth of field characteristic

Recording conditions	Aperture value	Small	Large
	Focal length	Telephoto	Wide-angle
	Distance to a subject	Close	Far
Depth of field (Focus range)	Shallow (narrow) Example: To take a picture by deliberately blurring the background		Deep (wide) Example: To take a picture by adjusting the focus while including the background

## Taking pictures by setting the aperture value and shutter speed

- You can take a picture even when Preview Mode is activated.
- The range in which you can check the effect of a selected shutter speed is between 8 seconds and 1/16000 seconds.
- This mode cannot be used with [ ] (4K Pre-Burst) of 4K Photo.

## Easily set aperture value / shutter speed for suitable exposure (One Push AE)

Recording mode: **P** **A** **S** **M**

When the exposure setting is too bright or too dark, you can use one push AE to achieve a suitable exposure setting.



### How to tell if the exposure is not adequate

**A** Blinks red

- If the aperture values and shutter speed blink red when the shutter button is pressed halfway.
- If the Manual Exposure Assistance (→68) is anything other than [ ] when in Manual Exposure Mode.

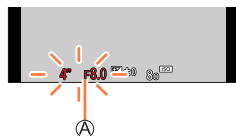

### Preparations

Assign [One Push AE] to the function button (→48)

### 1 (When exposure is not adequate) Press the function button

**B** Change to appropriate exposure

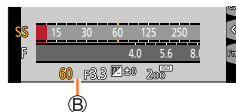

- In the following cases, suitable exposure cannot be set.
  - When the subject is extremely dark and it is not possible to achieve adequate exposure by changing the aperture value or shutter speed
  - When recording using the flash
  - Preview Mode

## Taking pictures according to the scene (Scene Guide Mode)

Recording mode: **[SCN]**

If you select a scene to suit the subject and recording conditions with reference to the example images, the camera will set optimal exposure, color, and focus, allowing you to record in a manner appropriate to the scene.

- 1 Set mode dial to **[SCN]**
- 2 Press **◀▶** to select the scene and press **[MENU/SET]**

• The scene can also be selected by dragging an example image or the slide bar.

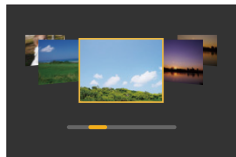

Displaying the description of each scene and recording tips

Press **[DISP.]** button while the scene selection screen is displayed

Normal display

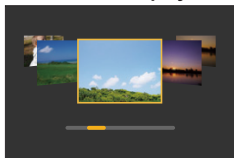

Guide display

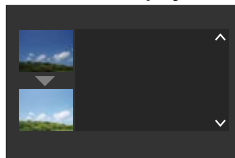

List display

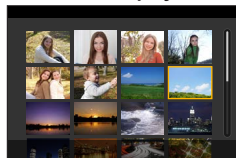

It is also possible to display the selection screen by touching the Recording mode icon in recording screen.





- Depending on the scene, the recording screen may seem as if frames are missed.
- To change the scene, select [Scene Switch] in the [Scene Guide] menu, and then press **[MENU/SET]**. You can return to step 2.
- Some of the recording menu items cannot be set in Scene Guide Mode because the camera automatically adjusts the settings to the optimal values.
- Although White Balance is fixed to [AWB] for certain types of scenes, you can fine tune the White Balance or use White Balance bracketing by pressing **[MENU/SET]**, going to the [Rec] menu, and selecting [White Balance]. (→109, 110)

## Taking pictures according to the scene (Scene Guide Mode)

**1: [Clear Portrait]****■ Setting [Soft Skin] and [Slimming Mode]**

You can apply the same [Soft Skin] and [Slimming Mode] settings as those specified for Self Shot Mode.

① Touch  and select the setting item

 OFF ([Soft Skin])	Makes people's faces look brighter and their skin tones look softer.
 OFF ([Slimming Mode])	Makes people look slimmer.

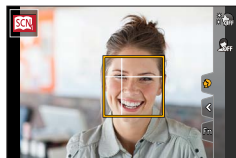

② Touch the slide bar

- You can set it to "Off" or a value in the range [1] to [10]. If you select the left edge of the slide bar (A), it will be set to "Off".

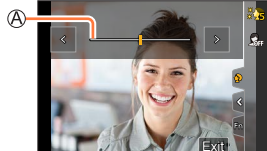

③ Touch [Exit]

- If you change AF Mode to a setting other than  (Face/Eye Detection), [Soft Skin] and [Slimming Mode] will become unavailable.

**2: [Silky Skin]**

- If a part of the background etc. is a color close to skin color, this part is also smoothed.
- This mode may not be effective when there is insufficient brightness.

**3: [Backlit Softness]****4: [Clear in Backlight]****5: [Relaxing Tone]****6: [Sweet Child's Face]**

- When you touch the face, a still picture is recorded with the focus and exposure set for the touched location.

**7: [Distinct Scenery]**

## Taking pictures according to the scene (Scene Guide Mode)

**8: [Bright Blue Sky]****9: [Romantic Sunset Glow]****10: [Vivid Sunset Glow]****11: [Glistening Water]**

- Star filter used in this mode may cause glistening effects on the objects other than water surface.

**12: [Clear Nightscape]****13: [Cool Night Sky]****14: [Warm Glowing Nightscape]****15: [Artistic Nightscape]****16: [Glittering Illuminations]****17: [Handheld Night Shot]**

- After the shutter button has been pressed, do not move the camera during the burst operation.
- The angle of view becomes narrow slightly.

**18: [Clear Night Portrait]**

- Tripod, self-timer recommended.
- When [Clear Night Portrait] is selected, keep the subject still for about 1 second after taking the picture.

**19: [Soft Image of a Flower]**

- For close-up recording, we recommend that you avoid using the flash.

## Taking pictures according to the scene (Scene Guide Mode)

**20: [Appetizing Food]**

- For close-up recording, we recommend that you avoid using the flash.

**21: [Cute Dessert]**

- For close-up recording, we recommend that you avoid using the flash.

**22: [Freeze Animal Motion]**

- Default [AF Assist Lamp] setting is [OFF].

**23: [Clear Sports Shot]****24: [Monochrome]**

## Taking Pictures with different picture effects

(Creative Control Mode)

Recording mode: 

You can select the effects to be applied from sample pictures and preview these effects on the screen.

**1** Set mode dial to 

**2** Press **▲ ▼** to select the picture effect (filters) and press **[MENU/SET]**

 Preview display

- You can also select the picture effects (filters) by touching the example images.

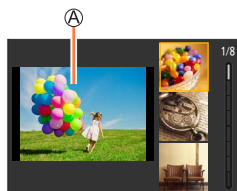

Displaying the description of each picture effect (Filter)

Press **[DISP.]** button while the picture effect selection screen is displayed

- When it is set to the guide display, explanations for each picture effect are displayed.

Normal display

Guide display

List display

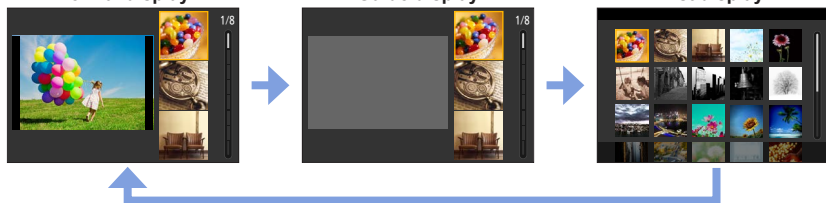

It is also possible to display the selection screen by touching the Recording mode icon in recording screen.



- Depending on the picture effect, the recording screen may seem as if frames are missed.
- [White Balance] will be fixed to [AWB] and ISO sensitivity to [AUTO].
- The following menu items can be set in the [Creative Control] menu.
  - [Filter Effect]: Allows you to set the picture effect (filter).
  - [Simultaneous Record w/o Filter]: Allows you to set the camera to take a picture with and without an picture effect simultaneously. (→172)



## Taking Pictures with different picture effects (Creative Control Mode)

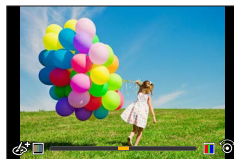

## Adjusting the picture effects according to your preferences

- 1 Press ► to display the setting screen
- 2 Rotate the control dial to adjust the setting conditions of the picture effects
  - Press [MENU/SET] to return to the recording screen.



Picture effect	Items that can be set
[Expressive]	Vividness Subdued coloring ↔ Gaudy coloring
[Retro]	Coloring Yellowish coloring ↔ Reddish coloring
[Old Days]	Contrast Low contrast ↔ High contrast
[High Key]	Coloring Pinkish coloring ↔ Light-bluish coloring
[Low Key]	Coloring Reddish coloring ↔ Bluish coloring
[Sepia]	Contrast Low contrast ↔ High contrast
[Monochrome]	Coloring Yellowish coloring ↔ Bluish coloring
[Dynamic Monochrome]	Contrast Low contrast ↔ High contrast
[Rough Monochrome]	Grainy picture effect Weak grainy picture effect ↔ Strong grainy picture effect
[Silky Monochrome]	Degree of defocusing Slight defocusing ↔ Strong defocusing
[Impressive Art]	Vividness Black & white ↔ Gaudy coloring
[High Dynamic]	Vividness Black & white ↔ Gaudy coloring

## Taking Pictures with different picture effects (Creative Control Mode)

Picture effect	Items that can be set
[Cross Process]	<p>Coloring Greenish coloring / Bluish coloring / Yellowish coloring / Reddish coloring</p> <ul style="list-style-type: none"> <li>• Rotate the control dial to select coloring, and press [MENU/SET].</li> </ul> 
[Toy Effect]	<p>Coloring Orangish coloring ↔ Bluish coloring</p>
[Toy Pop]	<p>Range in which peripheral brightness is reduced Small ↔ Large</p>
[Bleach Bypass]	<p>Contrast Low contrast ↔ High contrast</p>
[Miniature Effect]	<p>Vividness Subdued coloring ↔ Gaudy coloring</p> <ul style="list-style-type: none"> <li>• For details about [Miniature Effect] (→78)</li> </ul>
[Soft Focus]	<p>Degree of defocusing Slight defocusing ↔ Strong defocusing</p>
[Fantasy]	<p>Vividness Subdued coloring ↔ Gaudy coloring</p>
[Star Filter]	<p>[-x] Length of the rays of light Rays of light is short ↔ Rays of light is long [x*] Number of the rays of light Smaller ↔ Larger [x] Angle of the rays of light Rotate to the left ↔ Rotate to the right</p>
[One Point Color]	<p>Amount of color retained Leaves a small amount of color ↔ Leaves a large amount of color</p> <ul style="list-style-type: none"> <li>• For details about [One Point Color] (→79)</li> </ul>
[Sunshine]	<p>Coloring Yellowish coloring / Reddish coloring / Bluish coloring / Whitish coloring</p> <ul style="list-style-type: none"> <li>• Rotate the control dial to select coloring, and press [MENU/SET].</li> </ul>  <ul style="list-style-type: none"> <li>• For details about [Sunshine] (→79)</li> </ul>

## Taking Pictures with different picture effects (Creative Control Mode)

## ■ Setting the type of defocus ([Miniature Effect])

- ① After touching [📷], touch [📷]
- ② Press ▲▼ or ◀▶ to move the focusing area (frame)
  - You can also move the in-focus portion by touching the screen on the recording screen.
  - Touching [📷] allows you to set the recording orientation (defocus orientation).
- ③ Rotate the control dial to select the size of the focusing area (frame)
  - On the touch screen, spread (pinch out) your 2 fingers to zoom in, and pinch (pinch in) your 2 fingers to zoom out.
  - When you press [DISP.] button, the initial setting condition is restored.
- ④ Press [MENU/SET]

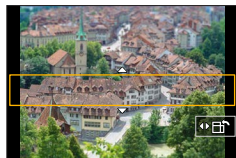

- No audio is recorded for motion pictures.

- **With camera models DC-ZS99P/DC-ZS99PP/DC-TZ99GD:**

When a motion picture is recorded, the finished recording will be approximately 1/10th of the actual recorded time period. (If you record a motion picture for 10 minutes, the resulting motion picture recording time will be approximately 1 minute.) The recordable time displayed on the camera is approx. 10 times of the actual recording time.

- **With camera models DC-TZ99E/DC-TZ99GA/DC-TZ99GH/DC-TZ99GN:**

When a motion picture is recorded, the finished recording will be approximately 1/8th of the actual recorded time period. (If you record a motion picture for 8 minutes, the resulting motion picture recording time will be approximately 1 minute.) The recordable time displayed on the camera is approx. 8 times of the actual recording time.

Depending on the recording frame rate of the motion picture, the recording time of the motion picture and the available recording time may differ from the values above.

- If you stop recording motion pictures too soon, the camera may continue recording until a certain time.

## Taking Pictures with different picture effects (Creative Control Mode)

### ■ Selecting the color to be retained ([One Point Color])

- ① After touching [📷], touch [🎨]
- ② Select the color to be retained with ▲ ▼ ◀ ▶ and press [MENU/SET]
  - You can also select it by touch operations.
  - When you press [DISP.] button, the initial setting condition is restored.

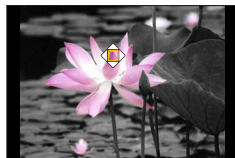

- The selected color may not be retained for some subjects.

### ■ Setting the position and size of the light source ([Sunshine])

- ① After touching [📷], touch [☀️]
- ② Press ▲ ▼ ◀ ▶ to move the center of the light source to a different position
  - The position of the light source can also be moved by touching the screen.
- ③ Rotate the control dial to adjust the size of the light source
  - On the touch screen, spread (pinch out) your 2 fingers to zoom in, and pinch (pinch in) your 2 fingers to zoom out.
  - When you press [DISP.] button, the initial setting condition is restored.
- ④ Press [MENU/SET]



#### Tips on positioning the center of the light source

You can move the center of the light source to a point outside the image to obtain a more natural finish.

## Taking Pictures with different picture effects (Creative Control Mode)

## Setting brightness (exposure)/blurriness of the background (Defocus control function)

## 1 Press ▲ to display the setting screen

- The brightness (exposure) operation screen is displayed. Press [Fn1] to operate the defocus control, and then press it again to finish the operation.

## 2 Rotate the control dial to set

- Press [MENU/SET] to return to the recording screen.

## When setting the brightness (exposure)

- You can change the setting content on the exposure compensation screen from [Exposure Comp. Disp. Setting] in the [Custom] ([Operation]) menu. (→185)

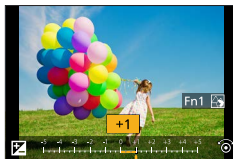

## When setting the background defocusing

- Pressing [5] button on the blurriness setting screen will cancel the setting.



## ■ With touch screen operations

- ① Touch [📷]
- ② Touch the item you want to set
  - [📷]: Adjusting the picture effect
  - [📷]: Degree of defocusing
  - [📷]: Brightness
- ③ Drag the slide bar or exposure meter to set
  - Press [MENU/SET] to return to the recording screen.



- Defocus control operation is not available in [Miniature Effect] (Creative Control Mode).

## Recording motion pictures by setting the aperture/ shutter speed/ISO sensitivity (Creative Video Mode)

Recording mode: 

The operation for changing the aperture value, shutter speed or ISO sensitivity is the same as the operation for setting the mode dial to [P], [A], [S] or [M] (except Program Shift Mode).

### 1 Set mode dial to

### 2 Set the menu

MENU →  [Creative Video] → [Exposure Mode]

Settings: [P] / [A] / [S] / [M]







It is also possible to display the selection screen by touching the Recording mode icon in recording screen.





### 3 Press the motion picture button (or shutter button) to start recording

① Touch  (Cannot be used during [High Speed Video] recording.)

② Touch icon

	Zoom		Exposure Compensation
	Aperture value		ISO sensitivity
	Shutter speed		

③ Drag the slide bar to set

	Changes the setting slowly
	Changes the setting quickly

Using touch icons allows silent operation while recording motion pictures.

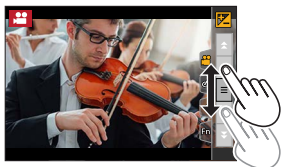

### 4 Press the motion picture button (or shutter button) to stop recording

## Recording motion pictures by setting the aperture/shutter speed/ISO sensitivity (Creative Video Mode)

- The ISO sensitivity can be set within the following range.
  - [AUTO], [80] to [3200]

### ■ Setting the upper limit value of ISO sensitivity when [Sensitivity] is set to [AUTO]

**MENU** →  [Motion Picture] → [ISO Auto Upper Limit (Video)]

Settings: [AUTO] / [200] / [400] / [800] / [1600] / [3200]

## Recording Slow Motion Pictures ([High Speed Video])

Slow motion pictures can be recorded by performing recording at a super high speed. When these recordings are played back, the motion is displayed slowly.

- To record pictures, use a UHS Speed Class 3 card.

### 1 Set mode dial to

### 2 Set the menu

**MENU** →  [Creative Video] → [High Speed Video]

With camera models DC-ZS99P/DC-ZS99PP/DC-TZ99GD:

[240fps/VGA]	Recording is done at 240 frames/second with [VGA] in MP4.
[120fps/HD]	Recording is done at 120 frames/second with [HD] in MP4.

With camera models DC-TZ99E/DC-TZ99GA/DC-TZ99GH/DC-TZ99GN:

[240fps/VGA]	Recording is done at 240 frames/second with [VGA] in MP4.
[200fps/VGA]	Recording is done at 200 frames/second with [VGA] in MP4.
[120fps/HD]	Recording is done at 120 frames/second with [HD] in MP4.
[100fps/HD]	Recording is done at 100 frames/second with [HD] in MP4.

### 3 Press the motion picture button (or shutter button) to start recording

### 4 Press the motion picture button (or shutter button) to stop recording

## Recording motion pictures by setting the aperture/shutter speed/ISO sensitivity (Creative Video Mode)

- When recording, the angle of view becomes narrower.
- No sound is recorded.
- **When the setting is [240fps/VGA]/[200fps/VGA]:**  
Files are split into smaller motion picture files for recording and playback when the continuous recording time exceeds 30 minutes or the file size exceeds 4 GB. (You can continue to record motion pictures without interruption.)
- **When the setting is [120fps/HD]/[100fps/HD]:**  
Files are split into smaller motion picture files for recording and playback when the file size exceeds 4 GB. (You can continue to record motion pictures without interruption.)  
Recording stops when the continuous recording time exceeds 29 minutes and 59 seconds. (In terms of playback time, you can record up to approximately 120 minutes.)
- The settings for the focus and zoom are fixed to the settings specified when recording was started.
- Flickering or horizontal stripes may appear while recording under fluorescent lighting.

## Recording motion pictures by setting the aperture/shutter speed/ISO sensitivity (Creative Video Mode)

## Pan or zoom while recording with the camera in a fixed position ([4K Live Cropping])

By cropping your motion picture down from the 4K angle of view to Full High Definition, you can record a motion picture that pans and zooms in/out while leaving the camera in a fixed position.



Pan



Zoom in

- Hold the camera firmly in place while recording.
- **With camera models DC-ZS99P/DC-ZS99PP/DC-TZ99GD:**
  - A motion picture will be recorded at [FHD/20M/30p] under MP4.
- **With camera models DC-TZ99E/DC-TZ99GA/DC-TZ99GH/DC-TZ99GN:**
  - A motion picture will be recorded at [FHD/20M/25p] under MP4.

### 1 Set mode dial to [P/M]

### 2 Set the menu

**MENU** → **M [Creative Video]** → **[4K Live Cropping]**

Settings: [40SEC] / [20SEC] / [OFF]

### 3 Set the crop start frame and press [MENU/SET] to set

#### Ⓐ Crop start frame

- When making settings for the first time, a crop start frame of size 1920×1080 is displayed.
- The camera will remember the frame position and size even when the camera is turned off.

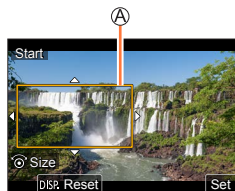

Operation	Touch operation	Description
▲▼◀▶	Touch	Moves the frame
🔄	Pinch out / Pinch in	Enlarges/reduces the frame (The range of settings allowed is from 1920×1080 to 3840×2160.)
[DISP.]	[Reset]	Returns the position of the frame and its size to the default settings
[MENU/SET]	[Set]	Decides the position and size of the frame

## Recording motion pictures by setting the aperture/shutter speed/ISO sensitivity (Creative Video Mode)

**4 Repeat step 3, and then set the crop end frame****B** Crop end frame

- The setting of [AF Mode] switches to [👤] (Face Detection). (The Eye Detection cannot be used.)

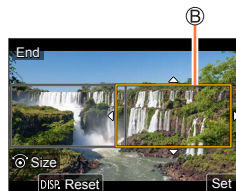
**5 Press the motion picture button (or shutter button) to start recording**

- C** Elapsed recording time
- D** Set operating time

- Immediately release the motion picture button (or shutter button) after pressing it.
- When the set operating time has elapsed, recording automatically ends. To end recording midway, press the motion picture button (or the shutter button) again.

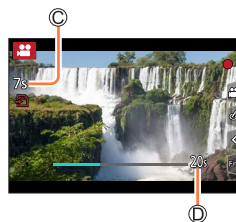

When you want to zoom in/out, set different angles of view for the cropping start and end frames. For example, to zoom in, set a larger angle of view for the start frame and a smaller angle of view for the end frame.

**■ Changing the position and size of a crop frame**

Press [Fn1] button while the recording screen is displayed, and perform steps **3** and **4**.

**■ To cancel [4K Live Cropping] recording**

Set [OFF] in step **2**.

- The angle of view narrows.
- [4K Live Cropping] recording cannot be performed when [High Speed Video] is set.
- Focus is adjusted and fixed in the crop start frame.
- [Continuous AF] is set to [OFF].
- [Metering Mode] will be [☉] (Multi Metering).
- You cannot zoom in/out during [4K Live Cropping] recording.

## Registering your own settings and recording

(Custom Mode)

Recording mode: **C1** / **C2**

### Registering your own settings ([Cust.Set Mem.])

Up to 4 sets of current camera settings can be registered using [Cust.Set Mem.].  
 ([C1], [C2-1], [C2-2], [C2-3])

- Initial setting of the Program AE Mode is registered as the custom settings initially.

#### Preparations

- Set in advance the recording mode and menu settings so that the camera can be in the state with the settings to be saved.

**MENU** →  **[Setup]** → **[Cust.Set Mem.]**  
 → **Custom set where you want to register settings**

- The following menu items are not registered as custom settings.

[Custom] menu	[Setup] menu	[Playback] menu
<ul style="list-style-type: none"> <li>• [Menu Guide]</li> <li>• Data registered with [Face Recog.]</li> <li>• The [Profile Setup] setting</li> </ul>	<ul style="list-style-type: none"> <li>• All menus</li> </ul>	<ul style="list-style-type: none"> <li>• [Rotate Disp.]</li> <li>• [Picture Sort]</li> </ul>

## Registering your own settings and recording (Custom Mode)

## Recording using registered custom set

## 1 Set mode dial to [C1] / [C2]

- In [C2], the last used custom set from [C2-1] to [C2-3] will be called up.

## ■ Changing the custom set of [C2]

- ① Set mode dial to [C2]
- ② Press [MENU/SET] to bring up the menu
- ③ Press ▲▼ to select the custom set you want to use, and press [MENU/SET]
  - The settings are switched to those settings you selected for the custom set.



When recording in [C2], it is also possible to display the selection screen by touching the Recording mode icon in recording screen.



## ■ Changing the registered content

Even if the menu settings are changed temporarily when the mode dial has been set to [C1] / [C2], the currently registered settings will remain unchanged. To change the currently registered settings, overwrite the registered data using [Cust.Set Mem.] on the [Setup] menu.

## Taking pictures with Auto Focus

Recording mode:

### 1 Press [] button (◀)

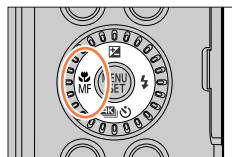

### 2 Press ◀▶ to select [AF] and press [MENU/SET]

- Set the focusing action when the shutter button is pressed halfway (→89)
- Switching [AF Mode] (→90)

### 3 Press the shutter button halfway

- Ⓐ Focus display  
(When focus is aligned: illuminated  
When focus is not aligned: flashing)
- Ⓑ AF area  
(When focus is aligned: green)

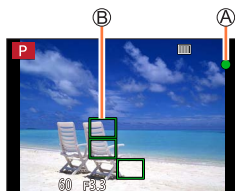

- Two “beep” sounds are heard and Auto Focus is activated.  
Four “beep” sounds when focus is not aligned.
- When you take a picture in a dark location, [] is displayed for the focus display and it may take longer to adjust focus than usual.



Subjects/environments which may make focusing difficult:

- Fast-moving or extremely bright objects, or objects with no color contrast.
- Taking pictures through glass or near objects emitting light.
- In the dark, or with significant jitter.
- When too close to object or when taking pictures of both distant and close objects together in the same picture.

- When the lighting is low making it difficult to focus with Auto Focus, set [Monitor Display Speed] to [60fps].

## Set the Focus Mode (AFS, AFF, AFC)

Recording mode:   P A S M   

The method for achieving focus when the shutter button is pressed halfway is set.

**MENU** →  **[Rec]** /  **[Motion Picture]** → **[AFS/AFF/AFC]**

Settings	The movement of the subject and the scene	Description
<b>[AFS]</b>	Subject is still (Scenery, anniversary photograph, etc.)	“AFS” is an abbreviation of “Auto Focus Single”. Focus is set automatically when the shutter button is pressed halfway. Focus will be fixed while it is pressed halfway.
<b>[AFF]</b>	Movement cannot be predicted (Children, pets, etc.)	“AFF” is an abbreviation of “Auto Focus Flexible”. In this mode, focusing is performed automatically when the shutter button is pressed halfway. If the subject moves while the shutter button is pressed halfway, the focus is corrected to match the movement automatically.
<b>[AFC]</b>	Subject is moving (Sport, trains, etc.)	“AFC” is an abbreviation of “Auto Focus Continuous”. In this mode, while the shutter button is pressed halfway, focusing is constantly performed to match the movement of the subject.



### When recording using [AFF], [AFC]

- When the subject is moving, the focusing is performed by predicting the subject position at the time of recording. (Movement prediction)
- Focusing may take time if the zoom is suddenly changed from max. Wide to max. Tele, or if you suddenly move closer to a subject from a greater distance.
- Press the shutter button halfway again when it is difficult to focus on the subject.
- While the shutter button pressed halfway, shake may be seen on the screen.

- [AFF] or [AFC] operates as [AFS] in the following case:
  - Creative Video Mode
  - When recording with  ([4K Burst(S/S)]) of the 4K Photo function.
  - When the lighting is low.
- [AFF] is not available when recording 4K photos. Continuous AF works during recording.
- This setting cannot be used when recording using [Post Focus].

## Switching [AF Mode]

Recording mode: **P** **A** **S** **M** **SCN**

This allows the focusing method that suits the positions and number of the subjects to be selected.

**MENU** → **[Rec]** / **[Motion Picture]** → **[AF Mode]**

**Settings:** **(Face/Eye Detection)** / **(Tracking)** / **(49-area-focusing)** / **etc. (Custom Multi)** / **(1-area-focusing)** / **(Pinpoint-focusing)**  
(→91 - 95)

- In Intelligent Auto Mode and Intelligent Auto Plus Mode, or can be set.
- The [AF Mode] is fixed to in the following case:
  - In Self Shot Mode (If is not available with the current recording mode, an available focus setting for each recording mode will be used.)
  - When recording using [4K Live Cropping]
- Auto Focus is fixed to in the following cases:
  - When using the Digital Zoom
  - [Miniature Effect] (Creative Control Mode)
- [AF Mode] cannot be set in the following cases:
  - When recording using [Post Focus]
  - When [Pull Focus] in [Snap Movie] is set to [ON]

## Taking pictures with Auto Focus

**Taking front-on pictures of people (Face/Eye Detection)**

The camera automatically detects the faces and eyes of subjects. The camera adjusts the focus on the eye that is closer to the camera and the exposure using the face (when [Metering Mode] is set to [AF]) (Multi Metering)).

- The camera can detect up to 15 faces. The camera can detect only the eye of face to be focused on.
- When the camera recognized a face, the AF area and eye used for focusing are displayed.

Ⓐ Eye used for focusing

Yellow: When the shutter button is pressed halfway and the subject is focused, the frame turns green.

White: Displayed when more than one face is detected. Other faces that are the same distance away as faces within the yellow AF area are also focused.

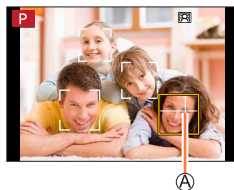
**Changing the eye to be in focus****Touch the eye to be used for focusing**

- If you touch [AF] or press [MENU/SET], the eye focus setting will be canceled.

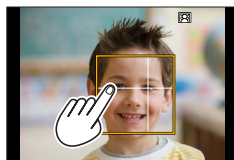

- Cannot set to [AF] (Face/Eye Detection) in the following cases:
  - [Clear Nightscape], [Cool Night Sky], [Warm Glowing Nightscape], [Artistic Nightscape], [Glittering Illuminations], [Handheld Night Shot], [Appetizing Food], [Cute Dessert] (Scene Guide Mode)
- The eye to be in focus cannot be changed when [4K Live Cropping] is set.
- If conditions prevent the face from being recognized, such as when the movement of the subject is too rapid, the AF Mode setting switches to [AF] (49-area-focusing).

## Automatically locking the focus on a moving subject (tracking)

### With cursor button operations

#### Align the AF Tracking area with the subject and press the shutter button halfway

 AF Tracking area

When the subject is recognized, the AF tracking area turns green. When you release the shutter button, the AF tracking area turns yellow and the subject is automatically kept in focus.

- To release AF Tracking → Press [MENU/SET].
- Focus range: same as macro recording [] (→100)

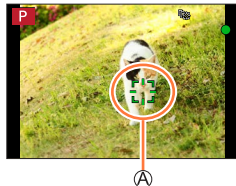





### With touch screen operations

#### Touch the subject

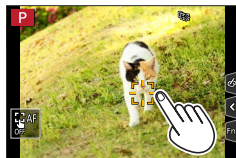
Perform these operations with the touch shutter function released. The AF Tracking area turns yellow while the subject is locked.

- To release AF Tracking → Touch [].



- If AF Lock fails, a red frame flashes for a while and then turns off.
- When you set [Metering Mode] to [] (Multi Metering), the camera adjusts the exposure using a locked subject. (→173)
- Under certain recording conditions, such as when the subject is small or dark, AF Tracking may not operate correctly. When AF Tracking does not work, focus will be on [] (1-area-focusing).
- This function is not available in the following case:
  - When using [Time Lapse Shot]
- In the following cases, [] performs the operation of [] (1-area-focusing).
  - [Glistening Water], [Glittering Illuminations], [Soft Image of a Flower], [Monochrome] (Scene Guide Mode)
  - [Sepia], [Monochrome], [Dynamic Monochrome], [Rough Monochrome], [Silky Monochrome], [Soft Focus], [Star Filter], [Sunshine] (Creative Control Mode)
  - [Monochrome] ([Photo Style])

## Taking pictures with Auto Focus

**Subject not centered in picture**  (49-area-focusing)

Focuses on the subject in the wide range area (up to 49-area-focusing) on the recording screen.

**Setting the shape of an AF area** , etc. (Custom Multi)

You can set the preferred shape of an AF area by selecting 49 points in the AF area, based on the subject.





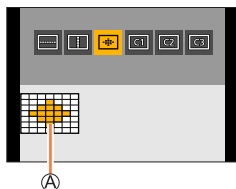

**MENU** →  **[Rec]** /  **[Motion Picture]** → **[AF Mode]**

**1** Select a Custom Multi icon (, etc.), and press **▲**

**2** Use **◀▶** to select the setting item

(A) Current AF area shape



 ((Horizontal Pattern))	Ideal shape for panning, etc.	
 ((Vertical Pattern))	Ideal shape for recording structures, etc.	
 ((Central Pattern))	Ideal shape for focusing around the center.	
 /  /  (Custom)	You can set a custom registration shape.	

**3** Press **▼**

- The AF area setting screen appears.

## 4 Select the AF area

Ⓑ Selected AF area

When selecting [ ] / [ ] / [ ]

① Change the shape of an AF area

Operation	Touch operation	Description
▲▼◀▶	Touch	Moves position
	Pinch out / Pinch in	Changes the size (3 stages)
[DISP.]	[Reset]	Resets the AF area back to the center. • If you press the button again, the size will be reset to the initial setting.

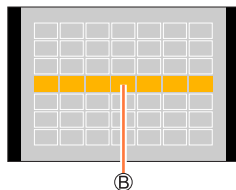

② Press [MENU/SET]

When selecting [C1] / [C2] / [C3]

① Change the shape of an AF area

### With cursor button operations

Use ▲▼◀▶ to select AF area and press [MENU/SET] to set (repeat)

- If you press [MENU/SET] again, the setting will be canceled.
- To cancel all the settings, press the [DISP.] button.

### With touch screen operations

Touch the parts you want to set as AF areas

- If you touch one of the selected AF areas, the selection of the area will be canceled.

② Press [Fn2] button

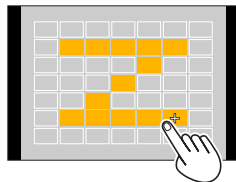

## ■ Registering the set AF area in [C1], [C2] and [C3] (Custom)

① Press ▲ on the screen of step 2

② Use ▲▼ to select the registration target icon and press [MENU/SET]

- During 4K Photo recording or while recording motion pictures with [Continuous AF], the camera focuses on the center of the AF area.
- The settings adjusted in [ ], [ ] or [ ] will be restored to the default settings when the camera is turned off.

**Determined position for focus [■] (1-area-focusing) /****[+] (Pinpoint-focusing)****[■] (1-area-focusing)**

Focuses on the AF area.



When the subject is not in the center of the composition in [■], you can bring the subject into the AF area, fix the focus and exposure by pressing the shutter button halfway, move the camera to the composition you want with the shutter button pressed halfway, and then take the picture. (Only when [AFS/AFF/AFC] in [Rec] menu is set to [AFS].)





**[+] (Pinpoint-focusing)**

Enables more precise focusing on a smaller point than [■] (1-area-focusing). When you press the shutter button halfway, an enlarged display of the focus position appears.

- If [+] (Pinpoint-focusing) is selected while recording motion pictures or 4K photos, the setting is changed to [■] (1-area-focusing).
- Cannot set to [+] (Pinpoint-focusing) in the following case:
  - When [AFS/AFF/AFC] in [Rec] menu is set to [AFF] or [AFC]

## Changing the position and size of the AF area

Recording mode: 



When [, [, [, or [] in Auto Focus Mode is selected, you can change the position and size of the AF area. With [, you can set the lock-on position.

- You can also display the AF area setting screen by touching the recording screen. (When [Touch AF] in [Touch Settings] of the [Custom] ([Operation]) menu has been set to [AF].)
- Perform these operations with the touch shutter function released.

- When you set [Metering Mode] to [] (spot-focusing), the metering target will move along with the AF area.
- The position and size of the AF area cannot be changed in the Digital Zoom range.



### ■ When selecting [] / [] / []

**MENU** →  **[Rec]** /  **[Motion Picture]** → **[AF Mode]**

- ① Select [, [, or [] and press ▼
  - The AF area setting screen appears.





### ② To change the AF area

Operation	Touch operation	Description
	Touch	To move the position of the AF area.
—	Pinch out / Pinch in	Enlarges/reduces the AF area in small steps.*
	—	Enlarges/reduces the AF area in large steps.*
<b>[DISP.]</b>	<b>[Reset]</b>	Resets the AF area back to the center. <ul style="list-style-type: none"> <li>• If you press the button again, the size will be reset to the initial setting.</li> </ul>

\* Not available when [] is selected.

### ③ Press [MENU/SET]

- AF area with the same function as [] is displayed in the set position, when the [] is selected. Setting of the AF area is cleared when [MENU/SET] is pressed or [] is touched.

## Taking pictures with Auto Focus

### ■ When selecting [AF]

You can set the focus position by selecting an AF area group. The AF area, which is configured with 49 points, is divided into groups consisting of 9 points each (6 points or 4 points for the groups located at the edges of the screen).

**MENU** → **[Rec] / [Motion Picture]** → **[AF Mode]**

- ① Select [AF] and press ▼
  - The AF area setting screen appears.
- ② Press ▲▼◀▶ to select an AF area group
- ③ Press [MENU/SET]
  - Setting of the AF area is cleared when [MENU/SET] is pressed or [AF] is touched.

#### Examples of group

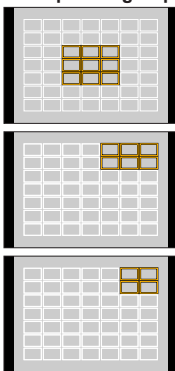

## Taking pictures with Auto Focus

## ■ When selecting [+]

You can enlarge the screen to perform more precise settings of the focus position.

- You cannot set the focus position at the edges of the screen.

**MENU** → **📷 [Rec]** / **👤 [Motion Picture]** → **[AF Mode]**

- Select **[+]** and press **▼**
- Use **▲▼◀▶** to set the focus position and press **[MENU/SET]**
  - The enlarged screen will appear for setting the focus position.

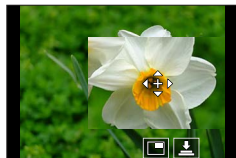

- Move **[+]** to the focus position

Operation	Touch operation	Description
▲▼◀▶	Touch	Moves [+].
—	Pinch out / Pinch in	Enlarges/reduces the screen in small steps.
	—	Enlarges/reduces the screen in large steps.
—		Switches the enlarged display. (windowed/full screen)
<b>[DISP.]</b>	<b>[Reset]</b>	Returns to the screen of step ②.

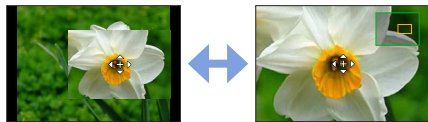

- The image of a part of the screen can be enlarged or reduced approximately 3 to 6 times. The image of the entire screen can be enlarged or reduced approximately 3 to 10 times.
- It is also possible to record a picture by touching **[📷]**.



- Press **[MENU/SET]**

## Optimizing the focus and brightness for a touched position

Recording mode: 



MENU →  [Custom] →  [Operation] → [Touch Settings] → [Touch AF]  
→ [AF+AE]

### 1 Touch the subject you want to optimize the brightness for

- The AF area with the same function as  is displayed on the touched position. (→96)
- The brightness optimization position is displayed on the center of the AF area. The position follows the movement of the AF area.
- [Metering Mode] is set to , which is used exclusively for the [Touch AE].



### 2 Touch [Set]

- If you touch  (touch ) when  is set), the setting of [AF+AE] is canceled.



When the background has become too bright, etc., the brightness contrast with the background can be adjusted by compensating the exposure.

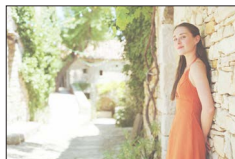

- When recording with the Touch Shutter, the focus and brightness are optimized for the touched position before recording takes place.
- At the edge of the screen, the metering may be affected by the brightness around the touched location.
- The [AF+AE] does not function in the following cases:
  - When using the Digital Zoom
  - When recording using [4K Live Cropping]

## Taking close-up pictures (Macro recording)

Recording mode: **PAS**

This mode allows you to take close-up pictures of a subject, e.g. when taking pictures of flowers.

**1** Press button (◀)

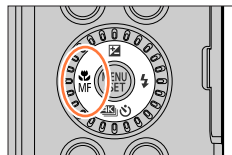

**2** Press ◀▶ to select the item and press [MENU/SET]

 ([AF Macro])	You can take pictures of a subject as close as 3 cm (0.098 feet) from the lens by rotating the zoom lever upmost to Wide.
 ([Macro Zoom])	Use this setting to get close to the subject and then further enlarge when taking the picture. You can take a picture with the Digital Zoom up to 3x while maintaining the distance to the subject for the extreme Wide position (3 cm (0.098 feet)). <ul style="list-style-type: none"> <li>• Note that enlarging will decrease picture quality.</li> <li>• Zoom range will be displayed in blue (digital zoom range).</li> </ul>

- When recording a subject close to the camera, we recommend taking a picture without using the flash.
- A picture may be out of focus when the subject is out of focus range, even if the focus display is lit.
- When a nearby subject is to be recorded
  - Using a tripod and [Self Timer] (→130) is recommended.
  - The effective focus range (depth of field) is significantly narrowed. Therefore, if the distance between the camera and the subject is changed after focusing on the subject, it may become difficult to focus on it again.
  - Resolution may be slightly reduced around the edges of the picture. This is not a malfunction.
- Cannot set to [Macro Zoom] in the following cases:
  - [Handheld Night Shot] (Scene Guide Mode)
  - When recording with [High Speed Video]
  - [Impressive Art], [Toy Effect], [Toy Pop], [Miniature Effect] (Creative Control Mode)
  - When [HDR] is set to [ON]
  - When [Quality] is set to [RAW ], [RAW ] or [RAW]

## Taking pictures with Manual Focus

Recording mode: 

Manual Focus is convenient when you want to lock the focus to take pictures or when it is difficult to adjust focus using Auto Focus.

- 1 Press  button (◀)
- 2 Press ◀▶ to select [MF] and press [MENU/SET]

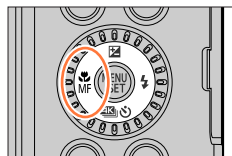

- 3 Turn the control ring to adjust focus

Turning the control ring to the right:

Focusing on a nearby subject

Turning the control ring to the left:

Focusing on a distant subject

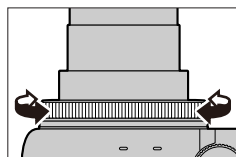

Ⓐ MF Assist (Enlarged screen)



Ⓑ MF Guide (→190)

Ⓒ Peaking

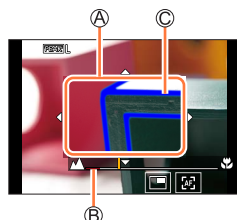
- Color is added to the portions of the image that are in focus. (Peaking) (→187)
- The screen changes to the assist screen and an enlarged display appears. (MF Assist)  
You can move the enlarged part by dragging the screen.
- You can also enlarge the display by pinching out or touching the screen twice.



## Taking pictures with Manual Focus

Operation	Touch operation	Description
▲▼◀▶	Drag	Moves the enlarged area.
—	Pinch out / Pinch in	Enlarges/reduces the screen in small steps.
	—	Enlarges/reduces the screen in large steps.
—		Switches the enlarged display. (windowed/full screen)* 
[DISP.]	[Reset]	Resets the area to be enlarged back to the center. • If you press the button again, the size will be reset to the initial setting.

\* The image of a part of the screen can be enlarged or reduced approximately 3 to 6 times. The image of the entire screen can be enlarged or reduced approximately 3 to 10 times.

## 4 Press the shutter button halfway

- The recording screen will be displayed.
- The same operation can be performed by pressing [MENU/SET].



### Quickly adjusting the focus using Auto Focus

In Manual Focus, the focus can be set on the subject through Auto Focus.

#### 1 Touch

- Auto Focus is activated at the center of the frame.
- Auto Focus also works with the following operations.
  - Pressing the function button to which [AF-ON] is assigned ([→48](#))
  - Dragging the monitor and releasing your finger at the position you want to focus on
- This function cannot be used when [4K Live Cropping] is set.

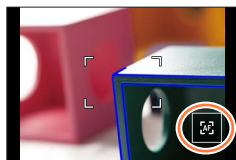

## Taking pictures by locking the focus and/or exposure

(AF/AE Lock)

**Recording mode:** 

You can use the AF/AE Lock function to fix the focus and exposure in advance and change the composition of the picture when recording. This function is convenient when you want to focus on the edge of the screen or when your subject is back-lit.

### Preparation

Assign [AF/AE LOCK] to the function button. (→48)

- 1 Point the camera at the subject**
- 2 Lock the focus and/or exposure while you press and hold the function button**
  - When you release the function button, the focus and/or exposure lock is canceled.
- 3 While you press and hold the function button, move the camera to compose the picture you want to take and fully press the shutter button**

### ■ Setting the function of [AF/AE LOCK]

**MENU** →  **[Custom]** →  **[Focus / Release Shutter]** → **[AF/AE Lock]**

<b>[AE LOCK]</b>	Locks exposure only. • [AEL] is displayed when the correct exposure is achieved.
<b>[AF LOCK]</b>	Locks focus only. • [AFL] is displayed when the subject comes into focus.
<b>[AF/AE LOCK]</b>	Locks focus and exposure. • [AFL] and [AEL] are displayed when the subject is in focus and the correct exposure is achieved.
<b>[AF-ON]</b>	Auto Focus is activated.

- AE Lock is disabled in Manual Exposure Mode.
- AF Lock is disabled during Manual Focus.
- Program Shift can be set even when AE is locked.

## Taking pictures with Exposure Compensation

Recording mode: **P** **A** **S** **M**

Corrects the exposure when there is a backlight or when the subject is too dark or too bright.

### 1 Press [**Q**] button (▲)

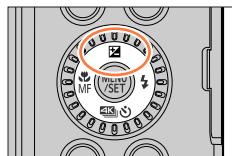

### 2 Rotate the control dial to compensate the exposure

Ⓐ Exposure Compensation

- You can change the setting content on the exposure compensation screen from [Exposure Comp. Disp. Setting] in the [Custom] ([Operation]) menu. (→185)

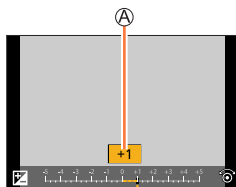

Under-exposed



Adjust the exposure to the [+]  
direction

Optimum exposure



Adjust the exposure to the [-]  
direction

Over-exposed

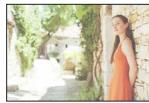

### 3 Press [MENU/SET] to set

- You can also press the shutter button halfway to set.

- In Manual Exposure Mode, you can correct the exposure only when the ISO sensitivity is set to [AUTO]. (You can select Exposure Compensation when the Quick menu is displayed by pressing the [Q.MENU] button.)
- You can set the exposure compensation value in the range between -5 EV and +5 EV. Settings can be made within a range of -3 EV to +3 EV while recording motion pictures, recording 4K photos, or recording in [Post Focus].
- Depending on the brightness, this may not be possible in some cases.
- When the Exposure Compensation value is out of the -3 EV to +3 EV range, the brightness of the recording screen will no longer change. It is recommended to record by checking the actual brightness of the recorded image in the Auto Review or playback screen.
- The set Exposure Compensation value is stored even if the camera is turned off. (When [Exposure Comp. Reset] is set to [OFF])

## Setting the ISO Sensitivity

Recording mode: **P** **A** **S** **M** SCN

Set ISO sensitivity (sensitivity to lighting).

**MENU** → **[Rec]** / **[Motion Picture]** → **[Sensitivity]**

### 1 Select the ISO sensitivity by rotating the control dial

ISO sensitivity

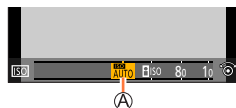

<b>AUTO</b>	ISO sensitivity is automatically set in a range up to 3200 (with the flash on: 1600)* <sup>1</sup> depending on the brightness of a subject.
<b>ISO</b> <b>(Intelligent ISO)</b>	ISO sensitivity is automatically set in a range up to 3200 (with the flash on: 1600)* <sup>1</sup> depending on the movement and brightness of a subject. <ul style="list-style-type: none"> <li>The shutter speed is not fixed when the shutter button is pressed halfway. It is continuously changing to match the movement of the subject until the shutter button is pressed fully.</li> </ul>
<b>From 80 to 3200,</b> <b>H.6400</b> * <sup>2</sup>	ISO sensitivity is fixed at the selected setting.

\*<sup>1</sup> When [ISO Auto Upper Limit (Photo)] in the [Rec] menu is set to [AUTO].

\*<sup>2</sup> Only when [Extended ISO] in the [Custom] ([Exposure]) menu is [ON].

### 2 Press **[MENU/SET]** to set

- You can also press the shutter button halfway to set.

## Setting the ISO Sensitivity



## Setting guide

ISO sensitivity	[80] ←→ [3200]
Location (recommended)	Bright (outdoors) Dark
Shutter speed	Slow Fast
Interference	Low High
Subject blur	High Low

- For details on the available flash range used when the ISO sensitivity is set to [AUTO], refer to (→147).
- Cannot select [ISO] in the following cases:
  - Shutter-Priority AE Mode
  - Manual Exposure Mode
- ISO sensitivity is set to [AUTO] (for motion pictures) while a motion picture is being recorded. (When not in Creative Video Mode)
- You can use the following ISO sensitivity settings when recording in Creative Video Mode ([Motion Picture] menu → [Sensitivity]), when recording 4K photos, or when recording using [Post Focus].
  - [AUTO], [80] to [3200]

## Adjusting the White Balance

Recording mode: **P** **A** **S** **M** **SCN**

This item adjusts to the color of white which is closest to what is seen by the eye in accordance with the light source.

**MENU** → **[Rec]** → **[White Balance]**

### 1 Rotate the control dial to select the White Balance

<p>[AWB]/ [AWBc]/ [AWBw]</p>	<p>Automatic adjustment in accordance with the light source.</p> <ul style="list-style-type: none"> <li>• Under a light source (such as an incandescent light) that produces reddish pictures:           <ul style="list-style-type: none"> <li>– [AWBc] gives higher priority to the original colors of the subject and reduces the reddish hue.</li> <li>– [AWBw] gives higher priority to what is seen by the eye and retains the reddish hue.</li> </ul> </li> <li>• When the white balance is set to [AWBc] or [AWBw], the adjustment effect may be similar to that of [AWB], depending on the light source.</li> </ul>
<p> [Sun]</p>	<p>Adjust to the color under a clear sky.</p>
<p> [Cloud]</p>	<p>Adjust to the color under a cloudy sky.</p>
<p> [House]</p>	<p>Adjust to the color in the shade.</p>
<p> [Light bulb]</p>	<p>Adjust to the color under incandescent lights.</p>
<p> [Flash]</p>	<p>Adjust to the color that is optimal for taking pictures using the flash.</p>
<p> [Grid]</p>	<p>Use the White Balance value that was set manually.</p> <ol style="list-style-type: none"> <li>① Press ▲</li> <li>② Point the camera at a white object such as a piece of paper, ensuring that it is inside the frame at the center of the screen, and press the shutter button           <ul style="list-style-type: none"> <li>• This will set the White Balance and return you to the recording screen.</li> <li>• It may not be possible to set the correct White Balance if subjects are too bright or too dark.</li> </ul> </li> </ol>
<p> [K]</p>	<p>You can set the White Balance using color temperature.</p> <ol style="list-style-type: none"> <li>① Press ▲</li> <li>② Use ▲▼ to select the color temperature value and press [MENU/SET]           <ul style="list-style-type: none"> <li>• You can set the color temperature from [2500K] to [10000K].</li> </ul> </li> </ol>

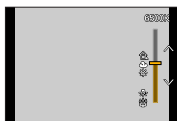

\* The [AWB] setting is applied while recording motion pictures, recording 4K photos, or recording in [Post Focus].

## 2 Press [MENU/SET] to set

- You can also press the shutter button halfway to set.



Under fluorescent lighting, LED lighting fixtures, etc., the optimal White Balance will vary depending on the lighting type, so use [AWB], [AWBc], [AWBw], [☀️], [🌧️], [🌃] or [🕯️].

- The White Balance may not operate correctly if you take pictures using a flash and the subject is recorded outside of the effective flash range.
- In Scene Guide Mode, settings suitable for each scene are made.
- In Scene Guide Mode, changing the scene or recording mode will return White Balance settings (including the White Balance fine adjustment setting) back to [AWB].

### ■ Auto White Balance

When [AWB] (Automatic White Balance) is set, the coloring is adjusted in accordance with the light source. However, if the scene is too bright or too dark or if other extreme conditions apply, the pictures may appear reddish or bluish. The White Balance may not operate correctly if there is a multiple number of light sources. In that case, set the [White Balance] to settings other than [AWB], [AWBc] or [AWBw] to adjust the coloring.

: [AWB] operational range

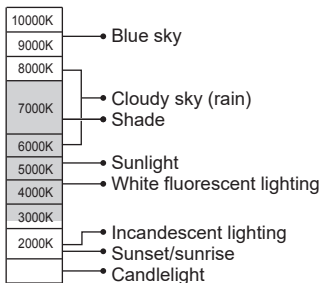

K=Kelvin Color Temperature

## Adjusting the White Balance

**Performing White Balance fine adjustments**

White Balance settings can be individually fine-tuned if colors still do not appear as anticipated.

**1** In step **1** of “Adjusting the White Balance” (→107), select the White Balance and press ▼

**2** Use ▲ ▼ ◀ ▶ to perform White Balance fine adjustments

- ◀: A (amber: orangish colors)      ▶: B (blue: bluish colors)
- ▲: G (green: greenish colors)      ▼: M (magenta: reddish colors)

- You can also make fine adjustments by touching the White Balance graph.
- Pressing [DISP.] button resets the position back to the center.

**3** Press [MENU/SET] to finalize the setting

- Press the shutter button halfway to return to the recording screen.

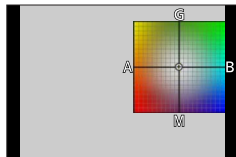

- When you perform fine adjustments of the White Balance toward the A (amber) or B (blue) side, the color of the White Balance icon displayed on the screen will change to the fine-tuned color.
- When you perform fine adjustments of the White Balance toward the G (green) or M (magenta) side, [+] or [-] will be displayed in the White Balance icon on the screen.

## Adjusting the White Balance

**Bracket recording using White Balance**

Bracket settings are performed based on the fine adjustment values for White Balance, and three pictures with different coloring are automatically recorded when the shutter button is pressed once.

**1 Perform fine adjustments of the White Balance in step 2 of “Performing White Balance fine adjustments” (→109) and rotate the control dial to perform the Bracket setting**

- You can also set the bracket by touching [◀▶]/[◀▶]/[◀▶]/[◀▶].

**2 Press [MENU/SET] to finalize the setting**

- Press the shutter button halfway to return to the recording screen.

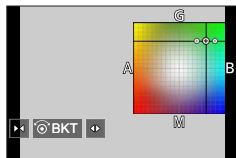

- You can also set the White Balance Bracket in [Bracket] in the [Rec] menu. (→137)
- This function is not available in the following cases:
  - [Glistening Water], [Glittering Illuminations], [Handheld Night Shot], [Soft Image of a Flower] (Scene Guide Mode)
  - When using [Burst]
  - When recording 4K photos
  - When recording using [Post Focus]
  - When taking still pictures while a motion picture is being recorded
  - When [Quality] is set to [RAW:⚡], [RAW:⚡] or [RAW]
  - When using [Time Lapse Shot]
  - When [Auto Shooting] of [Stop Motion Animation] is set to [ON]

## Selecting a Drive Mode

Recording mode: **P** **A** **S** **M**

You can switch the operation to be performed when you press the shutter button.

### 1 Press [ ] button (▼)



### 2 Press ◀▶ to select the drive mode and press [MENU/SET]

Ⓐ Drive Mode

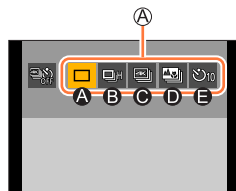

Ⓐ [Single]	When the shutter button is pressed, only one picture is recorded.
Ⓑ [Burst] (→112)	The pictures are recorded in succession while the shutter button is pressed.
Ⓒ [4K PHOTO] (→114)	When the shutter button is pressed, a picture is recorded with the 4K Photo function.
Ⓓ [Post Focus] (→125)	When the shutter button is pressed, the pictures are recorded with [Post Focus].
Ⓔ [Self Timer] (→130)	When the shutter button is pressed, recording takes place after the set time has elapsed.

- Select [] to return to [Single] (default setting).

## Burst function

Recording mode: **P** **A** **S** **M**

### ■ Setting [Burst Rate]

- ① Select [Burst] and pressing ▲ in step 2 (→111)
- ② Select the burst rate with ◀▶, and press [MENU/SET]

		[H] (High speed)	[M] (Middle speed)	[L] (Low speed)
Speed (pictures/sec.)	[AFS] / [MF]	10	5	2
	[AFF] / [AFC]	5		
Live View during burst recording	[AFS] / [MF]	None	Available	Available
	[AFF] / [AFC]	Available		
Number of recordable pictures*1	With RAW files	26 or more		
	Without RAW files	100 or more		

\*1 When recording is performed under the test conditions specified by Panasonic.

Pictures can be taken until the card becomes full. However, the burst speed will become slower halfway through the recording. The number of burst pictures is limited by the picture-taking conditions and the type and/or status of the card used.

### ■ About the maximum number of pictures that can be taken continuously

When you press the shutter button halfway, the maximum number of pictures you can take continuously will appear. You can check the approximate number of pictures that can be taken before the burst speed slows down.

Example: When 20 pictures can be taken: [r20]



- Once recording starts, the maximum number of pictures that can be taken continuously will decrease. When [r0] appears, the burst speed will slow down.
- When [r99+] is displayed, you can take 100 or more pictures continuously.

### ■ To cancel the burst function

Press [ ] button (▼), and then select [] ([Single]) or [] ([Off])



### Focusing in burst mode

Focusing varies depending on focus settings and the setting of [Focus/Release Priority] in the [Custom] ([Focus / Release Shutter]) menu.

Focus settings	[Focus/Release Priority]	[H]	[M], [L]
[AFS]	[FOCUS]/ [BALANCE]/ [RELEASE]	At the first picture	
[AFF] / [AFC]*2	[FOCUS]	Predicted focusing*3	Normal focusing*4
	[BALANCE]/ [RELEASE]	Predicted focusing*3	
[MF]	—	Focus set with Manual Focus	

\*2 Focus is fixed in the first picture when dark subjects are recorded.

\*3 The camera predicts the focus within a possible range by giving higher priority to the burst speed.

\*4 Since the camera records a burst of pictures while it adjusts the focus, the burst speed may be slower.

- The burst speed may become slower depending on the following settings: [Sensitivity], [Picture Size], [Quality], [AFS/AFF/AFC], [Focus/Release Priority]
- When the burst speed is set to [H] (when focus mode is [AFS] or [MF]), the exposure is fixed at the settings used for the first picture for the subsequent picture as well. In other cases, the camera adjusts the exposure for each frame.
- **It may take a while to store still pictures that were taken using the burst function. If you continue to record while storing, the number of burst pictures that can be taken will be reduced. A high-speed card is recommended when recording using the burst function.**
- This function is not available in the following cases:
  - [Glistening Water], [Glittering Illuminations], [Handheld Night Shot], [Soft Image of a Flower] (Scene Guide Mode)
  - [Rough Monochrome], [Silky Monochrome], [Miniature Effect], [Soft Focus], [Star Filter], [Sunshine] (Creative Control Mode)
  - In Self Shot Mode
  - When recording using the flash
  - When using [Time Lapse Shot]
  - When [Auto Shooting] of [Stop Motion Animation] is set to [ON]

## Recording with the 4K Photo function and selecting pictures to save

### Recording with the 4K Photo function

Recording mode:    **PAS**    

You can take burst pictures of approximately 8 million pixels with a burst rate of 30 fps. You can select and save a frame from the burst file.

- To record pictures, use a UHS Speed Class 3 card.

**1** Press   button (▼)





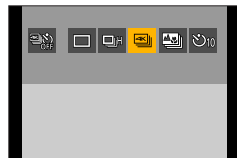

**2** Press ◀▶ to select 4K Photo and then press ▲

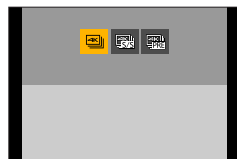

**3** Press ◀▶ to select the recording method and press [MENU/SET]

- The recording method can also be set using [4K PHOTO] in the [Rec] menu.







 <b>[4K Burst]</b>	<b>For capturing the best shot of a fast-moving subject</b> (e.g., sports, aeroplanes, trains) Audio recording: None
 <b>[4K Burst(S/S)]</b> "S/S" is an abbreviation of "Start/Stop".	<b>For capturing unpredictable photo opportunities</b> (e.g., plants, animals, children) Audio recording: Available*
 <b>[4K Pre-Burst]</b>	<b>For recording as needed whenever a photo opportunity arises</b> (e.g., the moment when a ball is thrown) Audio recording: None

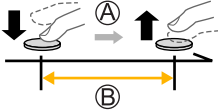

\* Audio is not played back when you perform playback with the camera.

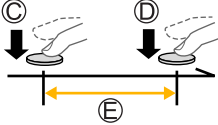
## Recording with the 4K Photo function and selecting pictures to save

## 4 Recording with the 4K Photo function

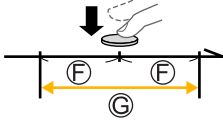

 <p>[4K Burst]</p>	<p>① <b>Press the shutter button halfway</b></p> <p>② <b>Press and hold the shutter button fully for as long as you want to perform recording</b></p> <ul style="list-style-type: none"> <li>Recording will start approximately 0.5 seconds after you press the shutter button fully. Therefore, press the button fully slightly in advance.</li> </ul> <p>Ⓐ Press and hold</p> <p>Ⓑ Recording is performed</p> 
 <p>[4K Burst(S/S)]</p> <p>“S/S” is an abbreviation of “Start/Stop”.</p>	<p>① <b>Press the shutter button fully</b></p> <ul style="list-style-type: none"> <li>Recording will start.</li> </ul> <p>② <b>Press the shutter button fully again</b></p> <ul style="list-style-type: none"> <li>Recording will stop.</li> </ul> <p>Ⓒ Start (First)</p> <p>Ⓓ Stop (Second)</p> <p>Ⓔ Recording is performed</p>  <p> When you press the [Fn1] button while recording, you can add a marker. (Up to 40 markers for each recording.) When selecting and saving pictures from a 4K burst file, you can skip to the positions where you added markers.</p>

## Recording with the 4K Photo function and selecting pictures to save

 <p>[4K Pre-Burst]</p>	<p>① <b>Press the shutter button fully</b></p> <ul style="list-style-type: none"> <li>The camera adjusts the focus continuously when using Auto Focus. Except when in Manual Exposure Mode, it also adjusts the exposure continuously.</li> <li>Images may not be displayed as smoothly as when recording with the normal recording screen.</li> </ul> <p>Ⓕ Approximately 1 second</p> <p>Ⓖ Recording is performed</p> <div style="text-align: right;">  </div> <hr/> <p> In situations where you want to lock focus and exposure, such as when the subject is not at the center, use [AF/AE LOCK]. (→103)</p>
---	--

- Burst pictures are saved as a single 4K burst file in the MP4 format.
- When [Auto Review] is enabled, the picture selection screen will be displayed automatically. To continue recording, press the shutter button halfway to display the recording screen.
- For information on how to select and save pictures from 4K burst files, refer to (→117).

### ■ To cancel the 4K Photo functions



Press [] button (▼), and then select [] ([Single]) or [] ([Off])

### Taking pictures of yourself (4K Selfie)

You can switch to 4K Photo Mode and take pictures of yourself. (→62)

- In Self Shot Mode, you can take pictures with [4K Burst (Wide-angle)], a setting that allows you to include a wider background. (In modes other than Self Shot Mode, the setting will switch to [4K Burst].)

### Battery drainage and camera temperature

- If the surrounding temperature is high or 4K photos are recorded continuously, [] may be displayed and recording may be stopped halfway through. Wait until the camera cools down.
- When [] ([4K Pre-Burst]) is set, the battery drains faster and the camera temperature rises. (to protect itself, the camera may switch to [] ([4K Burst]))  
Select [] ([4K Pre-Burst]) only when recording.

## Recording with the 4K Photo function and selecting pictures to save

## Selecting pictures from 4K burst file and saving

**1 Select a picture with the [▲] on the playback screen, and press ▲**

- The same operation can be performed by touching [▲].
- In the case of recording with [4K] ([4K Pre-Burst]), proceed to the step **3**.

**2 Drag the slide bar to perform rough scene selection**

- For information on how to operate the slide view screen, refer to (→118).
- If you touch [ ] (or press the [Fn2] button), you can choose a scene in the 4K burst playback screen. (→119)

Slide view screen

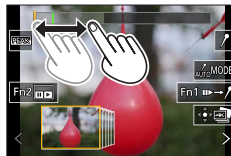
**3 Drag to select the frame you want to save as a picture**

- The same operation can be performed using ◀▶.

**4 Touch [ ] to save the picture**

- The selected picture will be saved as a new picture in the JPEG format separate from the 4K burst file.
- The picture will be saved with recording information (Exif information), including its shutter speed, aperture and ISO sensitivity information.











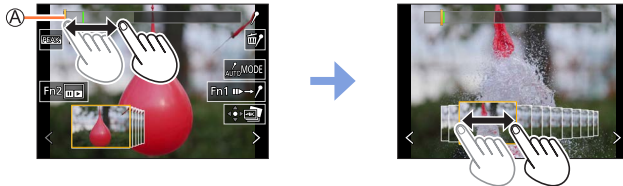

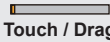

If you use [4K PHOTO Bulk Saving] in the [Playback] menu, you can bulk save 5 seconds' worth of 4K recording. (→213)

## Recording with the 4K Photo function and selecting pictures to save

## &lt;Slide view screen&gt;

Ⓐ Position of the displayed frame



Operation	Touch operation	Description
—	 Touch / Drag	Selects the scenes to be displayed • Scenes preceding and following the selected frame will be displayed in slide view.
	 Drag	Selects the frame • To switch the slide view, select the frame at either end and touch [ <b>&lt;</b> ] or [ <b>&gt;</b> ].
 Press and hold	 Touch and hold	Continuously scrolls the scene or frame-by-frame backward or forward.
	<b>Pinch out / Pinch in</b>	Enlarges/reduces the display
	<b>Drag</b>	Moves the enlarged area (during enlarged display)
—	 AUTO MODE	Switches a marker to be displayed (→121)
[Fn1]		Switches to marker operation (→120)
[Fn2]		Displays the 4K burst playback screen
—		Adds/deletes a marker
—		In-focus portions are highlighted with color. ([Peaking]) • Switches in order of [ <b>PEAK</b> OFF] → [ <b>PEAK</b> L] ([LOW]) → [ <b>PEAK</b> H] ([HIGH]).
[MENU/SET]		Saves the picture

## Recording with the 4K Photo function and selecting pictures to save

## &lt;4K burst playback screen&gt;

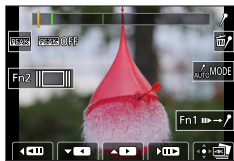

During pause

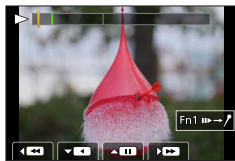

During continuous playback

Operation	Touch operation	Description
—	<b>Touch / Drag</b>	Selects the scenes to be displayed (while paused)
▲		Continuous playback* / Pause (during continuous playback)
▼		Continuous rewind* / Pause (during continuous rewind)
		Fast forward playback / Single-frame forward (while paused)
		Fast rewind playback / Single-frame rewind (while paused)
	<b>Pinch out / Pinch in</b>	Enlarges/reduces the display (while paused)
▲▼◀▶	<b>Drag</b>	Moves the enlarged area (during enlarged display)
—		Switches a marker to be displayed (→121)
[Fn1]		Switches to marker operation (→120)
[Fn2]		Displays the slide view screen (while paused)
—		Adds/deletes a marker
—		In-focus portions are highlighted with color. ([Peaking]) • Switches in order of [PEAK OFF] → [PEAK L] ([LOW]) → [PEAK H] ([HIGH]).
[MENU/SET]		Saves the picture (while paused)

\* 4K burst files recorded with [4K Burst (Wide-angle)] are played back or rewound continuously at 2x the normal speed.

- You can also zoom in by quickly touching the touch screen twice. (If the display was enlarged, it returns to the same magnification ratio.)

## Recording with the 4K Photo function and selecting pictures to save

## Marker

When selecting and saving pictures from a 4K burst file, you can select pictures easily by skipping between marked positions.

Two types of markers are available.

**White marker:** This is manually set during recording or playback.

**Green marker:** This is automatically set by the camera during recording. (Auto Marking function)

Marker operation screen



### ■ Skips to the marked positions

When [⏮→/↶] is touched on the slide view screen or 4K burst playback screen, the marker operation screen appears and you can skip to the marked positions. Touch [↷→/⏭] to return to the original operation.

Operation	Touch operation	Description
⏮/▶	⏮/▶	Moves to the previous/next marker.



### Auto Marking function

The camera automatically sets markers on scenes in which a face or the movement of a subject is detected.

(Example: At the scene when a vehicle passes by, a balloon bursts, or a person turns around)

- Up to 10 markers are displayed for each file.
- In the following cases, markers may not be set by the Auto Marking function depending on the recording conditions and the status of subjects.
  - The camera is moving because of panning or jitter
  - The movement of a subject is slow/small, or the subject is small
  - A face is not facing front

## Recording with the 4K Photo function and selecting pictures to save

### ■ Switches a marker to be displayed

Touch  on the slide view screen, 4K burst playback screen, or marker operation screen.

<b>[Auto]</b>	Displays a marker on a scene in which a face or the movement of a subject is detected.
<b>[Face Priority]</b>	Displays a marker with preference given to a scene in which a face is detected.
<b>[Motion Priority]</b>	Displays a marker with preference given to a scene in which the movement of a subject is detected.
<b>[Off]</b>	Displays manually set markers only.

- You cannot delete markers set by the Auto Marking function.
- The markers set by the Auto Marking function may not be displayed correctly if you split the 4K burst file on a device other than this camera and then play it back on the camera.
- In the following case, markers set by the Auto Marking function are not displayed.
  - 4K burst files recorded with [4K Pre-Burst]

## Recording with the 4K Photo function and selecting pictures to save

## Notes on the 4K Photo function

### ■ To change the aspect ratio

Selecting [Aspect Ratio] in the [Rec] menu allows you to change the aspect ratio for 4K photos.

### ■ To record the subject with reduced blur

You can reduce the blur of the subject by setting a faster shutter speed.

① Set mode dial to [S]



② Set the shutter speed by rotating the control dial

- Approximate shutter speed for outdoor recording in fine weather conditions: 1/1000 seconds or faster.
- If you increase the shutter speed, the ISO sensitivity becomes higher, which may increase the noise on the screen.

### ■ Preventing camera shake when you are recording pictures

When you perform [Light Composition] or [Sequence Composition], we recommend using a tripod and taking pictures remotely by connecting the camera to a smartphone to prevent camera shake. ([→233](#))

### ■ Shutter sound for 4K photo recording

- When using [] ([4K Burst]) or [] ([4K Pre-Burst]), you can change the electronic shutter sound settings in [Shutter Vol.] and [Shutter Tone]. ([→197](#))
- When recording with [] ([4K Burst(S/S)]), you can set the start/stop tone volume in [Beep Volume].
- You can perform high speed burst recording quietly using the 4K Photo function in combination with [Silent Mode]. ([→176](#))

### ■ Scenes not suitable for the 4K Photo function

#### Recording indoors

When recording under fluorescent lighting or LED lighting fixtures, etc., the colors and brightness may change or horizontal striping may appear on the screen. The striping may be reduced by setting a slower shutter speed.

#### Fast-moving subjects

Subjects moving fast may appear distorted when recorded.

## Recording with the 4K Photo function and selecting pictures to save

### ■ The camera's setup for the 4K Photo function

The camera's setup is automatically optimized for 4K photo recording.

- The following settings are fixed.

	[4K] (8M)	
[Picture Size]	[4:3]: 3328×2496 [16:9]: 3840×2160	[3:2]: 3504×2336 [1:1]: 2880×2880
[Quality]		
[Shutter Type]	[ESHTR]	
[Rec Quality]*	[4K/100M/30p]	
[Continuous AF]*	[ON]	

\*Settings in the [Motion Picture] menu are not applied to 4K burst files recorded with the 4K Photo function.

- The following limitations apply to the recording functions indicated below.

	([4K Burst])/  ([4K Burst(S/S)])	([4K Pre-Burst])
Program Shift	Disabled	
Exposure Compensation	-3 EV to +3 EV	
Shutter speed	1/30 to 1/16000	
[Min. Shtr Speed]	1/1000 to 1/30	
[AFS/AFF/AFC] ([AFF])	Disabled	
[AF Mode] ([])	Disabled	
[MF Assist]	○	Disabled
White Balance ([])	Disabled	
ISO sensitivity	[AUTO], [80] to [3200]	
Flash	Disabled	
Bracket recording	Disabled	

- The following menu items are disabled:

[Intelligent Auto]	[iHandheld Night Shot], [iHDR]
[Creative Control]	[Simultaneous Record w/o Filter]
[Rec]	[Picture Size], [Quality], [Flash Adjust.], [Shutter Type], [Bracket], [HDR]
[Custom]	[Rec Area], [Face Recog.], [Profile Setup]
[Setup]	[Power Save Mode] (Only  ([4K Pre-Burst])), [Monitor Display Speed]

## Recording with the 4K Photo function and selecting pictures to save

- Recording stops when the continuous recording time exceeds 15 minutes.  
When using an SDHC memory card, files are split into smaller picture files for recording and playback if the file size exceeds 4 GB. (You can continue to record pictures without interruption.)  
If using an SDXC memory card, you can record pictures in a single file even if the size is greater than 4 GB.
- When recording, the angle of view becomes narrower. (Except when recording with [4K Burst (Wide-angle)])
- The following changes occur when recording 4K photos:
  - [Destination] in [Travel Date] cannot be recorded.
  - [Simultaneous Record w/o Filter] in [Filter Settings] is not available.
  - It is not possible to use the HDMI output.
- When recording using the [4K Pre-Burst] ([4K Pre-Burst]) function, Step Zoom does not operate.
- Scene Detection in Intelligent Auto Mode works the same way as when recording motion pictures.
- The 4K Photo function is disabled when using the following settings:
  - [Clear in Backlight], [Glistening Water], [Artistic Nightscape], [Glittering Illuminations], [Handheld Night Shot], [Clear Night Portrait], [Soft Image of a Flower] (Scene Guide Mode)
  - [Rough Monochrome], [Silky Monochrome], [Miniature Effect], [Soft Focus], [Star Filter], [Sunshine] (Creative Control Mode)
  - During motion picture recording
  - When using [Time Lapse Shot]
  - When using [Stop Motion Animation]
- To select and save pictures from 4K burst files on a PC, use the software "PHOTOfunSTUDIO".  
Please note that it is not possible to edit a 4K burst file as a motion picture.

## Adjusting the focus after recording

(([Post Focus])/[Focus Stacking])

Recording mode:   **PAS** **M**    

You can record 4K burst pictures while changing the focus point and then select a focus point after recording. This function is best for non-moving subjects.

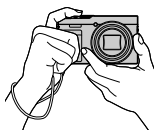

4K burst recording with automatic focus shift



Touch the desired focus point



Finished picture has the desired focus point

- To record pictures, use a UHS Speed Class 3 card.
- We recommend using a tripod to perform [Focus Stacking].

## Recording using [Post Focus]

**1** Press  button

**2** Press ◀▶ to select [ON] and press [MENU/SET]

 [Post Focus] icon

- You can also set it to [ON] by pressing the   button (▼), using ◀▶ to select a [Post Focus] icon ().

**3** Determine the composition and press the shutter button halfway

- Auto Focus activates and automatically detects the focus point on the screen. (While the shutter button pressed halfway, shake may be seen on the screen.)
- If there is no focus point on the screen, the Focus indicator (●) blinks and you cannot record.



**From halfway pressing the shutter button to completion of recording**

- Do not change the distance to subject or the composition.

## Adjusting the focus after recording ([Post Focus]/[Focus Stacking])

**4 Press the shutter button fully to start recording****B** Recording progress bar

- The focus point changes automatically while recording. When the recording progress bar disappears, recording automatically ends.
- The data will be saved as a single file in the MP4 format.
- If [Auto Review] is set, a screen will automatically appear that lets you select the focus point. (→127)

**■ Canceling [Post Focus]**

Select [OFF] in step **2**.

- The operation can be canceled by pressing the [**4K** ] button (**▼**) and then selecting [**□**] ([Single]) or [**OFF**].

**About camera temperature**

If the surrounding temperature is high or [Post Focus] recording is performed continuously, [**△**] may be displayed and recording may be stopped halfway through. Wait until the camera cools down.

## Adjusting the focus after recording ([Post Focus]/[Focus Stacking])

## Select the focus point and save the picture ([Post Focus])

1 On the playback screen, select the image with the  icon and press .









- The same operation can be performed by touching .



## 2 Touch the focus point

- If there are no pictures with the focus on the selected point, a red frame will be displayed, and pictures cannot be saved.
- The edge of the screen cannot be selected.



Operation	Touch operation	Description
 	Touch	Selects focus point <ul style="list-style-type: none"> <li>No selection can be made while display is enlarged.</li> </ul>
		Enlarges the display
		Reduces the display (when in enlarged display)
[Fn1]		Switches to [Focus Stacking] operation (→128)
[Fn2]		In-focus portions are highlighted with color. ([Peaking]) <ul style="list-style-type: none"> <li>Switches in order of [PEAK OFF] → [PEAK L] ([LOW]) → [PEAK H] ([HIGH]).</li> </ul>
[MENU/SET]		Saves the picture

- You can make fine adjustments to the focus by dragging the slide bar during enlarged display. (The same operation can be performed using .)

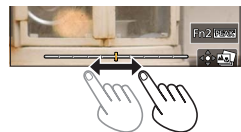
3 Touch  to save the picture

- The selected picture will be saved as a new separate file in the JPEG format.

## Adjusting the focus after recording ([Post Focus]/[Focus Stacking])

## Select the focus range to combine and create a single picture ([Focus Stacking])

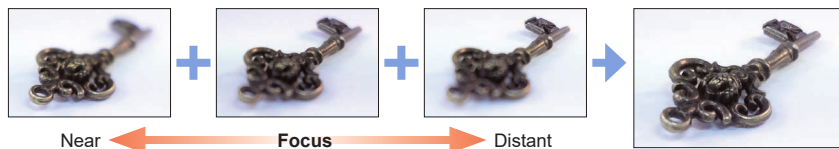

### 1 Touch on screen in step 2 of “Select the focus point and save the picture ([Post Focus])” (→127)

- The same operation can be performed by pressing the [Fn1] button.

### 2 Choose a stacking method and touch it



[Auto Merging]	Automatically select photos suitable for stacking and combine them into one picture. <ul style="list-style-type: none"> <li>• Choose by giving preference to near-focus pictures.</li> <li>• Perform the focus stacking and save the picture.</li> </ul>
[Range Merging]	Combine the pictures with the selected focus position into one picture.

(When selecting [Range Merging])

### 3 Touch the focus point

- Select positions at two or more points.
- Focus points between the selected two positions will be selected.
- Positions that cannot be selected, or that would produce an unnatural result will be grayed out.

- Touch a position again to deselect it.
- If you drag the screen you can then continue to select positions.

Operation	Touch operation	Description
		
	Touch	Select the position
[Fn2]	[Set/Cancel]	Set/Clear the position
[DISP.]	[All]	Select all positions (Before selecting position)
	[Reset]	Deselect All (After selecting position)
[MENU/SET]		Combine and save picture

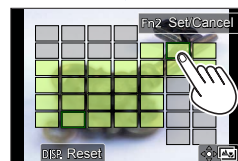
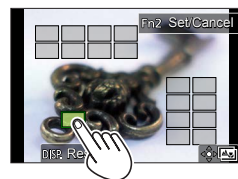

## Adjusting the focus after recording ([Post Focus]/[Focus Stacking])

### 4 Touch to combine and save the picture

- The picture will be saved in JPEG format with recording information (Exif information) from the nearest position's picture, including its shutter speed, aperture and ISO sensitivity information.

## Notes on the [Post Focus]/[Focus Stacking]

### ■ The camera's setup for recording in [Post Focus]

- Since recording is performed in the same picture quality as 4K photos, certain limitations apply to recording functions and menu settings. For details, refer to "The camera's setup for the 4K Photo function" (→123).
- In addition to the limitations of the 4K Photo function, the following limitations apply to [Post Focus] recording:
  - [AF Mode] and [AFS/AFF/AFC] cannot be set.
  - Manual Focus cannot be used.
  - The following [Custom] menu items cannot be set: [Shutter AF]
  - Motion pictures cannot be recorded.
  - [Digital Zoom] is not available.
- During recording, the angle of view will be narrower.
- The [Post Focus] function is disabled when using the following settings:
  - [Clear in Backlight], [Glistening Water], [Artistic Nightscape], [Glittering Illuminations], [Handheld Night Shot], [Clear Night Portrait], [Soft Image of a Flower] (Scene Guide Mode)
  - [Rough Monochrome], [Silky Monochrome], [Miniature Effect], [Soft Focus], [Star Filter], [Sunshine] (Creative Control Mode)
  - In Self Shot Mode
  - When using [Time Lapse Shot]
  - When using [Stop Motion Animation]
- When selecting the focus and saving pictures, you cannot select and save the picture from a TV screen even if the camera is connected to a TV through an HDMI micro cable.
- In the following cases, [Focus Stacking] may produce an unnatural picture:
  - If the subject is in motion
  - If there are large differences in distance to the subject
  - If there is significant blurring (recording with a larger aperture might make the picture less unnatural)
- During focus stacking, auto compensation is applied to deviations among pictures due to camera shake. In such cases, the angle of view will be slightly narrower at the time of focus stacking.
- Only pictures taken using [Post Focus] on this camera are eligible for [Focus Stacking].

## Taking pictures with self-timer

Recording mode:

### ■ Setting the self-timer operation

- ① Select [Self Timer] and pressing ▲ in step 2 (→111)
- ② Select the self-timer operation with ◀▶, and press [MENU/SET]

	The shutter is activated after 10 seconds.
	The shutter is activated after 10 seconds and three pictures are taken at intervals of approximately 2 seconds.
	The shutter is activated after 2 seconds. This is also effective for preventing jitter when pressing the shutter button.

### ■ To cancel the self-timer function

Press [] button (▼), and then select [] ([Single]) or [] ([Off])

- After the self-timer indicator flashes, recording will start.
- The focus and exposure are fixed when the shutter button is pressed halfway.
- We recommend using a tripod.
- It cannot be set to [] in the following cases:
  - When recording using [Bracket]
  - When [Simultaneous Record w/o Filter] of [Filter Settings] is set to [ON]
- This function is not available in the following cases:
  - In Self Shot Mode (When taking pictures in Self Shot Mode, you can set the Self-timer in [Countdown] (→59))
  - During motion picture recording
  - When using [Time Lapse Shot]
  - When [Auto Shooting] of [Stop Motion Animation] is set to [ON]

## Taking pictures automatically at set intervals

[Time Lapse Shot]

Recording mode:

You can preset data such as recording start time and time lapse to take still pictures automatically. This setting is convenient for taking pictures at constant intervals for landscape scenes, observation of the gradual changes in animals/plants, and other applications. The pictures are recorded as a set of group pictures.

- Complete the date and time settings in advance. (→31)

### 1 Set the menu

MENU →  [Rec] → [Time Lapse Shot]		
[Shooting Interval Setting]	<p>[ON]: Sets the time from recording start time to the next recording start time.</p> <p>[OFF]: After recording is finished, the next recording is started without any interval.</p>	
[Start Time]	[Now]	Starts the recording by fully-pressing the shutter button.
	[Start Time Set]	<p>Any time up to 23 hours 59 minutes ahead can be set.</p> <p>① Press ◀▶ to select the item (hour and/or minute), and ▲▼ to set the start time, and press [MENU/SET]</p>
[Image Count] / [Shooting Interval]*1	<p>◀▶ : Select the item (digit)</p> <p>▲▼ : Setting</p> <p>[MENU/SET]: Set</p>	

\*1 Can be set only when [Shooting Interval Setting] is set to [ON].



- The estimated recording ending time is displayed on the setting screen. (When [Shooting Interval Setting] is set to [OFF], the recording ending time is displayed only when the focus mode is set to [MF] in Shutter-Priority AE Mode or Manual Exposure Mode.)
- The camera may not be able to record using the pre-set interval and number of pictures to be recorded or may not finish recording at the estimated recording ending time under some recording conditions.

### 2 Press ▲ to select [Start] and press [MENU/SET]

## Taking pictures automatically at set intervals [Time Lapse Shot]

### 3 Focus on the subject and take a picture

- The recording starts by fully-pressing the shutter button.
- During recording standby, the camera turns off automatically when no operation is performed for a preset interval. The [Time Lapse Shot] recording will continue even if the camera is turned off, and the camera is automatically turned on at the recording start time. If you want to turn on the camera manually, press the shutter button halfway.
- Operations during recording standby (The camera is turned on)

Operation	Touch operation	Description
[Fn1]*2	 *3	Displays a selection screen that lets you pause or stop the recording
		Displays a selection screen that lets you resume or stop the recording (during pause)

\*2 When you record pictures by setting [Shooting Interval Setting] to [OFF], you can press [Fn1] even while recording is in progress. After recording (exposure) of a picture taken at the time when you pressed [Fn1] is finished, a selection screen is displayed.

\*3 When you record pictures by setting [Shooting Interval Setting] to [OFF], you cannot perform touch operation.

### 4 Select the motion picture creation method

[Rec Quality]	Sets the picture quality of the motion picture.
[Frame Rate]	Set the number of frames per second. The higher the number is, the smoother the motion picture will be.
[Sequence]	<b>[NORMAL]:</b> Stitches the still pictures in the recording sequence. <b>[REVERSE]:</b> Stitches the still pictures in the reverse order of recording.

### 5 Press ▲ to select [OK] and press [MENU/SET]

- You can also create a motion picture using [Time Lapse Video] in the [Playback] menu.

## Taking pictures automatically at set intervals [Time Lapse Shot]

- This function is not intended for application-specific systems (monitoring cameras).
- When using zoom, the camera could tilt when the lens barrel extends. Make sure to secure the camera in place with a tripod or by other means.
- [Time Lapse Shot] is paused in the following cases:
  - When the remaining battery power runs out
  - Turning the camera off

If the number of pictures set has not been taken yet, you can restart the operation by turning off the camera in the pause state, replacing the battery or card, and then turning the camera on again. (Note, however, that the pictures recorded after restarting the operation are saved as a separate set of group pictures.)

- We recommend using auto focus for time lapse recording in cases where a long [Shooting Interval] is set and the camera will turn off automatically between shots.
- When creating motion pictures at a picture quality size of [4K], recording times are limited to 29 minutes and 59 seconds.  
If using an SDHC memory card, you will not be able to create motion pictures with a file size greater than 4 GB. With an SDXC memory card, you can create motion pictures with a file size greater than 4 GB.
- When creating a motion picture with a picture quality size of [FHD] or [HD], you will be unable to create it if the recording time is more than 29 minutes and 59 seconds or the file size is greater than 4 GB.
- This function is not available in the following cases:
  - [Handheld Night Shot] (Scene Guide Mode)
  - In Self Shot Mode
  - When using [Stop Motion Animation]

## Creating stop motion animation [Stop Motion Animation]

Recording mode: **PAS**

You can stitch still pictures to create stop motion animation. The pictures are recorded as a set of group pictures.

- Complete the date and time settings in advance. (→31)

### 1 Set the menu

MENU →  [Rec] → [Stop Motion Animation]	
[Auto Shooting]	[ON]: Takes pictures automatically at a set recording interval. [OFF]: Takes pictures manually, one frame at a time.
[Shooting Interval]	(Only when [Auto Shooting] is set to [ON]) Set the interval used for [Auto Shooting].

### 2 Press ▲ to select [Start] and press [MENU/SET]

### 3 Press ▲ to select [New] and press [MENU/SET]

### 4 Focus on the subject and take a picture

### 5 Move the subject to decide on the composition (repeat)

- Up to 9,999 frames can be recorded.
- Repeat the recording of still pictures in the same way.
- When you turn off the camera during recording, a message to restart recording will appear when you turn on the camera.

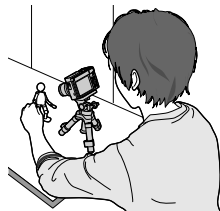

#### How to create stop motion animation effectively

- Up to two previously recorded pictures are displayed on the recording screen. Check this screen as a guideline for determining the amount of required motion.
- You can press [▶] (Playback) button to check the recorded pictures. Press [⏏] button to delete unnecessary pictures. To return to the recording screen, press [▶] (Playback) button again.

## Creating stop motion animation [Stop Motion Animation]

**6 Touch [ ] to end the recording**

- You can also end the recording by selecting [Stop Motion Animation] in the [Rec] menu, and then pressing [MENU/SET].
- When [Auto Shooting] is set to [ON], select [End] on the confirmation screen. (If you select [Pause], press the shutter button fully to resume recording.)

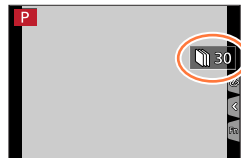
**7 Select a method to create a stop motion animation**

[Rec Quality]	Sets the picture quality of the motion picture.
[Frame Rate]	Set the number of frames per second. The higher the number is, the smoother the motion picture will be.
[Sequence]	[NORMAL]: Stitches the still pictures in the recording sequence. [REVERSE]: Stitches the still pictures in the reverse order of recording.

**8 Press ▲ to select [OK] and press [MENU/SET]**

- You can also create a stop motion animation using [Stop Motion Video] in the [Playback] menu.

**■ Adding pictures to an already recorded stop motion animation group**

When you select [Additional] in step **3**, group pictures recorded using [Stop Motion Animation] are displayed. Select a set of group pictures and press [MENU/SET]. Then, select [Yes] on the confirmation screen.

## Creating stop motion animation [Stop Motion Animation]

- [Auto Shooting] may not be performed according to the preset interval because recording could take time under some recording conditions, such as when pictures are taken using a flash.
- When creating motion pictures at a picture quality size of [4K], recording times are limited to 29 minutes and 59 seconds.  
If using an SDHC memory card, you will not be able to create motion pictures with a file size greater than 4 GB. With an SDXC memory card, you can create motion pictures with a file size greater than 4 GB.
- When creating a motion picture with a picture quality size of [FHD] or [HD], you will be unable to create it if the recording time is more than 29 minutes and 59 seconds or the file size is greater than 4 GB.
- You cannot select only one recorded still picture using [Additional].
- This function is not available in the following cases:
  - In Self Shot Mode
  - When using [Time Lapse Shot]
- [Auto Shooting] in [Stop Motion Animation] cannot be used in the following case:
  - [Handheld Night Shot] (Scene Guide Mode)

## Taking Pictures While Adjusting a Setting Automatically



(Bracket Recording)

Recording mode: 

You can take multiple pictures while automatically adjusting a setting by pressing the shutter button.

### 1 Set the menu

**MENU** →  **[Rec]** → **[Bracket]** → **[Bracket Type]**

 <b>(Exposure Bracket)</b>	Press the shutter button to perform recording while adjusting the exposure. (→138)
 <b>(White Balance Bracket)</b>	Press the shutter button once to take three pictures with different white balance settings automatically. (→110)

### 2 Press ▼ to select **[More Settings]** and then press **[MENU/SET]**

- For information on [More Settings], refer to the page that describes each function.
- Press the shutter button halfway to exit the menu.

### 3 Focus on the subject and take a picture

- When Exposure Bracket is selected, the bracket display flashes until all of the pictures you have set are taken. If you change the bracket settings or turn off the camera before all of the pictures you have set are taken, the camera restarts recording from the first picture.

#### ■ To cancel **[Bracket]**

Select **[OFF]** in step 1.

- Bracket recording is disabled in the following cases.
  - [Glistening Water], [Glittering Illuminations], [Handheld Night Shot], [Soft Image of a Flower] (Scene Guide Mode)
  - [Rough Monochrome], [Silky Monochrome], [Miniature Effect], [Soft Focus], [Star Filter], [Sunshine] (Creative Control Mode)
  - In Self Shot Mode
  - When recording using the flash (except for White Balance Bracket)
  - When recording motion pictures
  - When recording 4K photos
  - When recording using [Post Focus]
  - When using [Time Lapse Shot]
  - When [Auto Shooting] of [Stop Motion Animation] is set to [ON]

## Taking Pictures While Adjusting a Setting Automatically (Bracket Recording)

## Exposure Bracket

## ■ About [More Settings] (step 2 in (→137))

[Step]	Sets the number of pictures to be taken and the exposure compensation range. [3•1/3] (Takes three pictures with an interval of 1/3 EV) to [7• 1] (Takes seven pictures with an interval of 1 EV)
[Sequence]	Sets the order in which pictures are taken.
[Single Shot Setting]*	[□]: Takes one picture each time you press the shutter button. [📷]: Takes all the pictures set to be taken when you press the shutter button once.

\* Not available for burst recording. When using burst recording, if you press and hold the shutter button, recording will be performed continuously until a specified number of pictures are taken.

[Step]: [3•1/3], [Sequence]: [0/-/+]

1st picture

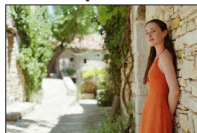

±0 EV

2nd picture



-1/3 EV

3rd picture

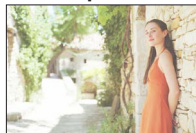

+1/3 EV

- When taking pictures using Exposure Bracket after setting the Exposure Compensation value, the pictures taken are based on the selected Exposure Compensation value.

## Correcting jitter

Recording mode:

Automatically detects and prevents jitter.

**MENU** → **[Rec]** / **[Motion Picture]** → **[Stabilizer]**

(Normal)	Corrects vertical and horizontal jitter.
(Panning)	Corrects vertical jitter. This setting is ideal for panning (technique of recording a subject by matching the camera movement with the movement of a subject going in a specific direction).
<b>[OFF]</b>	<b>[Stabilizer]</b> does not work.



### To prevent jitter

If a warning is displayed about jitter, use **[Stabilizer]**, a tripod, or **[Self Timer]**.

- Using a slower shutter speed can cause motion blur. Shutter speed will be slower particularly in the following cases. Keep the camera still from the moment the shutter button is pressed until the picture appears on the screen.

We recommend using a tripod.

- **[Slow Sync.]**
- **[Slow Sync./Red-Eye]**
- **[Clear Nightscape]**, **[Cool Night Sky]**, **[Warm Glowing Nightscape]**, **[Artistic Nightscape]**, **[Glittering Illuminations]**, **[Clear Night Portrait]** (Scene Guide Mode)



- When you use a tripod, we recommend setting [Stabilizer] to [OFF].
- In the following cases, the [Stabilizer] will switch to [(👉)] (Normal), even if it is set to [(👉)] (Panning):
  - During motion picture recording
  - When recording 4K photos
  - When recording using [Post Focus]
- [Stabilizer] cannot be used when recording with [High Speed Video].
- The 5-axis Hybrid Image Stabilizer function automatically functions while recording motion pictures. This decreases the jitter of the image when recording motion pictures while zooming or walking, etc.
  - The recording range may become narrower.
- In the following cases, The 5-axis Hybrid Image Stabilizer function is not available.
  - When using the Digital Zoom
  - **With camera models DC-ZS99P/DC-ZS99PP/DC-TZ99GD:**  
When recording motion pictures with [Rec Quality] set to [4K/100M/30p]
  - **With camera models DC-TZ99E/DC-TZ99GA/DC-TZ99GH/DC-TZ99GN:**  
When recording motion pictures with [Rec Quality] set to [4K/100M/30p] or [4K/100M/25p]
  - When recording using [4K Live Cropping]
- Cases where the stabilizer function may be ineffective:
  - When there is a lot of jitter
  - When the zoom magnification is high (also in the Digital Zoom range)
  - When taking pictures while following a moving subject
  - When the shutter speed becomes slower to take pictures indoors or in dark places
- The panning effect by selecting [(👉)] is not fully achieved in the following cases:
  - Bright summer days or other bright locations
  - When the shutter speed is higher than 1/100 seconds
  - When the motion of a subject is slow and the speed with which the camera is moved is too slow (a nice background blur is not achieved)
  - When the camera is not adequately tracking the motion of a subject

## Using Zoom

For details on zoom operations and the Zoom Compose Assist function, refer to (→35, 36).

### Zoom types and use

#### Optical Zoom

You can zoom in without degrading the picture quality.

**Maximum magnification: 30x**

- This function is not available in the following case:
  - When recording with [Macro Zoom]

#### Extended/Extra optical zoom

This function works when picture sizes with [EX] have been selected in [Picture Size]. Extended/Extra optical zoom allows you to zoom in using a higher zoom ratio than Optical Zoom, without degrading the picture quality. The maximum zoom ratio varies depending on the picture size.

**Maximum magnification: 59.2x (Including the optical zoom ratio.)**



- This function is not available in the following cases:
  - Creative Video Mode
  - [Handheld Night Shot] (Scene Guide Mode)
  - [Toy Effect], [Toy Pop] (Creative Control Mode)
  - When recording 4K photos
  - When recording using [Post Focus]
  - When [HDR] is set to [ON]
  - When [iHandheld Night Shot] is set to [ON]
  - When [iHDR] is set to [ON]
  - When [Quality] is set to [RAW]
  - When [Rec Area] is set to [👤]
  - When recording with [Macro Zoom]
  - During motion picture recording

**[i.Zoom]**

You can use the camera's Intelligent Resolution technology to increase the zoom ratio up to 2x higher than the original zoom ratio with limited deterioration of picture quality.

**MENU** →  **[Rec]** /  **[Motion Picture]** → **[i.Zoom]**

**Settings: [ON] / [OFF]**

- When [Picture Size] is set to [S], the zoom ratio can be increased to up to 1.5x the original zoom ratio.
- [i.Zoom] works automatically in Intelligent Auto Mode or Intelligent Auto Plus Mode.
- This function is not available in the following cases:
  - [Handheld Night Shot] (Scene Guide Mode)
  - [Impressive Art], [Toy Effect], [Toy Pop] (Creative Control Mode)
  - When recording with [Macro Zoom]
  - When [HDR] is set to [ON]
  - When [iHandheld Night Shot] is set to [ON]
  - When [iHDR] is set to [ON]
  - When [Quality] is set to [RAW , [RAW ] or [RAW]

**[Digital Zoom]**

Recording mode: **PAS** **M**

You can zoom in up to 4x the original zoom magnification. When [Digital Zoom] is used simultaneously with [i.Zoom], you can increase the combined zoom ratio up to 4x.

Note that, with Digital Zoom, enlarging will decrease picture quality.

**MENU** → **[Rec]** / **[Motion Picture]** → **[Digital Zoom]**

**Settings: [ON] / [OFF]**

- When using [Digital Zoom], we recommend using a tripod and the self-timer (→130) for taking pictures.
- The AF area is largely displayed at the center in the Digital Zoom range.
- This function is not available in the following cases:
  - When **[Monitor Display Speed]** is set to **[ECO 30fps]** (setting at the time of purchase)
  - [Handheld Night Shot] (Scene Guide Mode)
  - [Impressive Art], [Toy Effect], [Toy Pop], [Miniature Effect] (Creative Control Mode)
  - When recording using [Post Focus]
  - When recording with [High Speed Video]
  - When [HDR] is set to [ON]
  - When [Quality] is set to [RAW ], [RAW ] or [RAW]

The illustration is an example of when using Optical Zoom, [i.Zoom], and [Digital Zoom] in Program AE Mode.

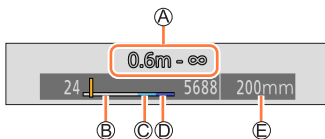

- Ⓐ Focus range
- Ⓑ Optical Zoom range
- Ⓒ i.Zoom range
- Ⓓ Digital Zoom range
- Ⓔ Current zoom position (Focal lengths the same as those of a 35 mm film camera)

## Using the zoom by performing touch operations (Touch zoom)

### 1 Touch [◀]

### 2 Touch [T/W↑]

- The slide bar is displayed.



### 3 Perform zoom operations by dragging the slide bar

- The zoom speed varies depending on the touched position.

[▼] / [▲]	Slow zooming
-----------	--------------

[▼] / [▲]	Fast zooming
-----------	--------------

- Touch [T/W↑] again to end touch zoom operations.



- This function is not available in the following case:

- In Self Shot Mode

## Taking pictures with flash

### Changing Flash Mode

Recording mode: P A S M

Set the flash to match the recording.

1 Press [] button (▶)

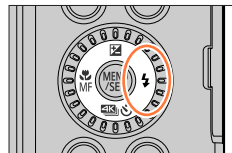

A : [Auto] A : Auto*	The flash is automatically activated when the recording conditions make it necessary.
A  : [Auto/Red-Eye]	The flash fires automatically to control red eye according to recording conditions. <ul style="list-style-type: none"> <li>• Use this when you take pictures of people in low lighting conditions.</li> </ul>
: [Forced Flash On] : [Forced On/Red-Eye]	The flash is activated every time regardless of the recording conditions. <ul style="list-style-type: none"> <li>• Use this when your subject is back-lit or under fluorescent light.</li> </ul>
S : [Slow Sync.] S  : [Slow Sync./Red-Eye]	Takes brighter pictures such as pictures of subjects against a nightscape by decreasing the shutter speed when firing a flash. <ul style="list-style-type: none"> <li>• Ideal for taking pictures of people against a nightscape.</li> <li>• Using a slower speed can cause motion blur. We recommend using a tripod.</li> </ul>
: [Forced Flash Off]	The flash is not activated in any recording conditions. <ul style="list-style-type: none"> <li>• Use this when you take pictures in places where the use of the flash is not permitted.</li> </ul>

\* This can be set only in Intelligent Auto Mode ( or ). The icon changes depending on the type of subject and brightness.

**The flash is activated twice. The interval between the first and second flash is longer when [ A ], [ ] or [ S ] is set. The subject should not move until the second flash is activated.**

- The red-eye reduction effect varies depending on the subject and is affected by factors such as distance from the subject and whether the subject is looking at the camera during the preliminary flash. In some cases, red-eye reduction may be negligible.

## Taking pictures with flash

## ■ Flash settings for each Recording mode (○: Available, –: Not available)

Recording mode*1		⚡A ⚡	⚡AⓄ ⚡Ⓞ	⚡S	⚡SⓄ	Ⓞ
<b>P</b>	Program AE Mode	○	○	○	○	○
<b>A</b>	Aperture-Priority AE Mode	○	○	○	○	○
<b>S</b>	Shutter-Priority AE Mode	○	○	–	–	○
<b>M</b>	Manual Exposure Mode	○	○	–	–	○
<b>SCN</b> Scene Guide Mode (●: Default settings)	[Clear Portrait]	○	●*4	–	–	○
	[Silky Skin]	○	●*4	–	–	○
	[Clear in Backlight]	●*2	–	–	–	○
	[Sweet Child's Face]	○	●*4	–	–	○
	[Clear Night Portrait]	–	–	–	●	○
	[Soft Image of a Flower]	●*3	–	–	–	○
	[Appetizing Food]	●*3	–	–	–	○
	[Cute Dessert]	●*3	–	–	–	○
	[Freeze Animal Motion]	●*3	–	–	–	○
	[Clear Sports Shot]	●*3	–	–	–	○
[Monochrome]	●*3	○	○	○	○	

\*1 For details about flash settings in Intelligent Auto Mode ([IA] or [IA+]), refer to (→54).

\*2 Cannot be set to [⚡A].





\*3 Default setting is [⚡A].



\*4 Default setting is [⚡AⓄ].

- The flash is fixed to [Ⓞ] (Forced Flash Off) in the following cases:
  - [Backlit Softness], [Relaxing Tone], [Distinct Scenery], [Bright Blue Sky], [Romantic Sunset Glow], [Vivid Sunset Glow], [Glistening Water], [Clear Nightscape], [Cool Night Sky], [Warm Glowing Nightscape], [Artistic Nightscape], [Glittering Illuminations], [Handheld Night Shot] (Scene Guide Mode)
  - During motion picture recording
  - When recording 4K photos
  - When recording using [Post Focus]
  - **When using the electronic shutter**
  - When [HDR] is set to [ON]
  - **When [Silent Mode] is set to [ON]**
  - When a picture effect in [Filter Effect] of [Filter Settings] is set
- The Scene Guide Mode flash setting is returned to the initial value with each change of scene.

## Taking pictures with flash

## ■ Shutter speeds for each flash mode

Flash Mode	Shutter speed (seconds)
	1/60*1 - 1/2000
	
	
	

Flash Mode	Shutter speed (seconds)
	1 - 1/16000
	
	4*2 - 1/16000

\*1 The shutter speed is set to 4 seconds in Shutter-Priority AE Mode and Manual Exposure Mode.

\*2 The shutter speed is set to 30 seconds in [Artistic Nightscape] (Scene Guide Mode).

- In Intelligent Auto Mode ([IA] or [IA<sup>+</sup>]), the shutter speed changes depending on the detected scene.

## ■ The available flash range

Edges of a picture may become slightly dark if using flash at short distances without using zoom (close to max. Wide). This may be remedied by using a little zoom.

Max. Wide	Max. Tele
Approx. 0.6 m - 5.6 m (2.0 feet - 18 feet)	Approx. 2.0 m - 2.9 m (6.6 feet - 9.5 feet)

- These ranges are obtained, the ISO sensitivity is set to [AUTO], and [ISO Auto Upper Limit (Photo)] is set to [AUTO].

- Avoid doing the following, as the heat or light could cause deformation or discoloration.
  - Putting the flash close to objects
  - Covering the flash with your hand as it is firing
- Flash charging may take time if battery is low or if using flash repeatedly. When the flash is being charged, the flash icon flashes red, and you cannot take a picture even when you fully press the shutter button.

## Adjusting the flash output

Recording mode:   **P** **A** **S** **M**   

Adjust the flash output if a picture taken using the flash is too bright or too dark.

**MENU** →  **[Rec]** → **[Flash Adjust.]**

### 1 Press ◀▶ to set the flash output and press **[MENU/SET]**

Settings: **-2 EV to +2 EV (unit: 1/3 EV)**

When you do not want to adjust the intensity of the flash, select **[±0 EV]**.

- When the intensity of the flash is adjusted, **[+]** or **[-]** is displayed on the flash icon.

## Recording Motion Pictures

Recording mode: 

You can record 4K or high-definition quality motion pictures in MP4 format. (→151)  
Audio is recorded in stereo.

## 1 Press the motion picture button to start recording

- Ⓐ Red REC frame indicator (→191)
- Ⓑ Recording state indicator
- Ⓒ Elapsed recording time
- Ⓓ Remaining recording time

- Recording of motion picture appropriate for each motion picture mode is possible.
- Immediately release the motion picture button after pressing it.
- While you are recording motion pictures, the recording status indicator (red) will light.

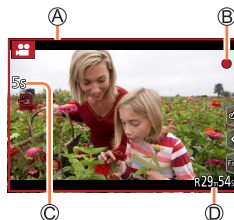
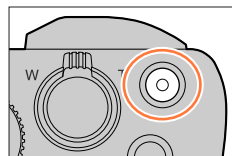

## 2 Press the motion picture button again to end recording

- **With recording in a quiet environment, the sound of aperture, focus and other actions may be recorded in motion pictures. This is not a malfunction.**

The focus operation during recording of motion pictures can be set to [OFF] in [Continuous AF]. (→153)



### About operation sound when recording ends



If the operation sound of the motion picture button pressed to end recording bothers you, try the following:

- Record the motion picture about three seconds longer, and then divide the last part of the motion picture using [Video Divide] (→220) in the [Playback] menu.

### ■ Recording motion picture in Creative Video Mode

You can record a motion picture by setting the aperture, shutter speed, and ISO sensitivity using touch operation. (→81)

## Recording Motion Pictures

- If the surrounding temperature is high, or a motion picture is recorded continuously, [] is displayed and recording may be stopped halfway through. Wait until the camera cools down.
- Note that if you perform operations such as zoom, using buttons or dials, while recording a motion picture, operation noise may be recorded.
- If Extended/Extra optical zoom is used before pressing the motion picture button, these settings will be cleared, and the recordable area will be changed significantly.
- If the aspect ratio is different for still pictures and motion pictures, the angle of view will change when starting to record a motion picture.  
When you set [Rec Area] to [, the angle of view setting used for recording motion pictures is displayed.
- The zoom speed will be slower than normal during motion picture recording.
- Depending on the type of the card, the card access indication may appear for a while after recording motion pictures. This is not a malfunction.
- ISO sensitivity is set to [AUTO] (for motion pictures) while a motion picture is being recorded. You can set ISO sensitivity and record motion pictures in Creative Video Mode.
- The below-mentioned motion picture recording modes are set in the following cases:

Selected Scene Guide Mode	Recording mode at the time of recording motion pictures
[Clear in Backlight]	Portrait Mode
[Clear Nightscape], [Artistic Nightscape], [Handheld Night Shot], [Clear Night Portrait]	Low Light Mode

- This function is not available in the following cases:
  - [Glistening Water], [Glittering Illuminations], [Soft Image of a Flower] (Scene Guide Mode)
  - [Rough Monochrome], [Silky Monochrome], [Soft Focus], [Star Filter], [Sunshine] (Creative Control Mode)
  - When [Post Focus] is set
  - When taking pictures with [Time Lapse Shot]
  - When taking pictures with [Stop Motion Animation]

## Setting the picture size and recording frame rate

### 1 Set the menu

**MENU** →  **[Motion Picture]** → **[Rec Quality]**

With camera models DC-ZS99P/DC-ZS99PP/DC-TZ99GD:

[Rec Quality]	Picture size	Recording frame rate	Sensor output	Bit rate
[4K/100M/30p]*	3840×2160	30p	30 fps	100 Mbps
[FHD/28M/60p]	1920×1080	60p	60 fps	28 Mbps
[FHD/20M/30p]	1920×1080	30p	30 fps	20 Mbps
[HD/10M/30p]	1280×720	30p	30 fps	10 Mbps

With camera models DC-TZ99E/DC-TZ99GA/DC-TZ99GH/DC-TZ99GN:

[Rec Quality]	Picture size	Recording frame rate	Sensor output	Bit rate
[4K/100M/30p]*	3840×2160	30p	30 fps	100 Mbps
[4K/100M/25p]*	3840×2160	25p	25 fps	100 Mbps
[FHD/28M/60p]	1920×1080	60p	60 fps	28 Mbps
[FHD/28M/50p]	1920×1080	50p	50 fps	28 Mbps
[FHD/20M/30p]	1920×1080	30p	30 fps	20 Mbps
[FHD/20M/25p]	1920×1080	25p	25 fps	20 Mbps
[HD/10M/30p]	1280×720	30p	30 fps	10 Mbps
[HD/10M/25p]	1280×720	25p	25 fps	10 Mbps

\* 4K motion pictures

## Recording Motion Pictures

- The quality becomes higher when the number of bit rate gets bigger. This unit uses the “VBR” recording method, and the bit rate is changed automatically depending on the subject to record. Therefore, the recording time is shortened when a subject with fast movement is recorded.
- 4K motion picture cannot be set when using [Miniature Effect] (Creative Control Mode).
- To record 4K motion pictures, use a UHS Speed Class 3 card.
- When you record 4K motion pictures, the angle of view will be narrower than motion pictures of other sizes.
- To ensure highly accurate focus, 4K motion pictures are recorded at reduced Auto Focus speeds. It may be difficult to focus on the subject with Auto Focus, but this is not a malfunction.
- Limitations on continuous recording (→30)

**■ About the compatibility of the recorded motion pictures**

Motion pictures recorded in MP4 may be played back with poor picture or sound quality or playback may not be possible even when played back with equipment compatible with the format. Also, the recording information may not be displayed properly.

- **With camera models DC-ZS99P/DC-ZS99PP/DC-TZ99GD:**
  - For details on motion pictures recorded with [4K/100M/30p] in the MP4 format, refer to “Enjoying 4K motion pictures” (→249).
- **With camera models DC-TZ99E/DC-TZ99GA/DC-TZ99GH/DC-TZ99GN:**
  - For details on motion pictures recorded with [4K/100M/30p], or [4K/100M/25p] in the MP4 format, refer to “Enjoying 4K motion pictures” (→249).

## Adjusting the focus while recording motion pictures ([Continuous AF])

Recording mode:        

Focusing varies depending on the setting of focus and the setting of [Continuous AF] in the [Motion Picture] menu.

**MENU** →  **[Motion Picture]** → **[Continuous AF]**

Focus setting	[Continuous AF]	Setting
[AFS]/[AFF]/[AFC]	[ON]	Allow the focus to be constantly adjusted automatically while recording motion pictures.
	[OFF]	Fix focus position at the start of motion picture recording.
[MF]	[ON] / [OFF]	Allow the focus to be adjusted manually.

- When the focus setting is set to [AFS], [AFF], or [AFC], the camera will refocus if the shutter button is pressed halfway while recording motion pictures.
- When Auto Focus is activated while you are recording motion pictures, the focusing operation sound may be recorded under some conditions. If you want to suppress this sound, we recommend taking pictures after setting [Continuous AF] to [OFF].
- When using zoom while recording motion pictures, it may take some time to focus.
- This function is not available in the following cases:
  - While [Pull Focus] in [Snap Movie] is in operation.
  - When recording with [High Speed Video]
  - When recording using [4K Live Cropping]



## Taking still pictures while a motion picture is being recorded

Recording mode:         

### 1 Press the shutter button fully during the motion picture recording

- Simultaneous recording indicator is displayed while recording still pictures.
- Recording with the Touch Shutter function is also available.



- Pictures will be recorded with a picture size determined by the [Rec Quality] setting for motion pictures.
- Up to 40 still pictures can be recorded during recording of the motion picture.  
(A motion picture with a [Rec Quality] size of [4K]: up to 10 pictures)
- The aspect ratio of a still picture is fixed to [16:9].
- Only pictures in JPEG file format are recorded when [Quality] is set to [RAW , [RAW , or [RAW].  
([Quality] is used with the  setting when [RAW] is set.)
- This function is not available in the following case:
  - When [Snap Movie] is set to [ON]

## Recording Snap Movies

Recording mode:   **P** **A** **S** **M**  

You can specify the recording time in advance and record motion pictures casually like you take snapshots. The function also allows you to shift a focus at the start of recording and add fade in/out effects in advance.

- **With camera models DC-ZS99P/DC-ZS99PP/DC-TZ99GD:**
  - Motion pictures will be recorded with [FHD/20M/30p] in MP4.
- **With camera models DC-TZ99E/DC-TZ99GA/DC-TZ99GH/DC-TZ99GN:**
  - Motion pictures will be recorded with [FHD/20M/25p] in MP4.
- Using the smartphone/tablet app “Panasonic Image App”, you can combine motion pictures recorded with the camera. Music can be added and various editing operations can be performed when you combine them.

**MENU** →  **[Motion Picture]** → **[Snap Movie]** → **[ON]**

- Press the shutter button halfway to exit the menu.

### 1 Press the motion picture button to start recording

- Ⓐ Elapsed recording time
- Ⓑ Set recording time

- Immediately release the motion picture button after pressing it.
- You cannot stop motion picture recording in the middle. The recording will stop automatically when the set recording time has elapsed.

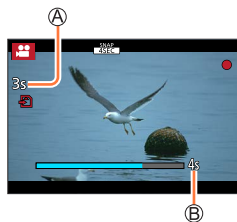

### ■ Deactivating Snap Movie

Set **[Snap Movie]** to **[OFF]**.

## ■ Changing the settings

**MENU** →  **[Motion Picture]** → **[Snap Movie]** → **[SET]**

<b>[Record time]</b>	Sets the recording time of motion pictures.
<b>[Pull Focus]</b>	Allows dramatic imaging expression by shifting focus gradually at the start of recording. (→157)
<b>[Fade]</b>	<p>Adds a fade-in (gradual appearance) effect to an image and audio as recording starts or adds a fade-out (gradual disappearance) effect to them as recording ends.</p> <p><b>[WHITE-IN] / [WHITE-OUT]:</b> Adds a fade-in or fade-out effect that uses a white screen.</p> <p><b>[BLACK-IN] / [BLACK-OUT]:</b> Adds a fade-in or fade-out effect that uses a black screen.</p> <p><b>[COLOR-IN] / [COLOR-OUT]:</b> Adds an effect that fades in from black-and-white to color or an effect that fades out from color to black-and-white. Audio will be recorded normally.</p> <p><b>[OFF]</b></p>

- Motion pictures recorded with [WHITE-IN] or [BLACK-IN] are displayed as all-white or all-black thumbnails in Playback Mode.
- If you assign [Snap Movie] to [Fn Button Set] in [Custom] ([Operation]) menu (→48), you can display a screen that lets you switch [Snap Movie] between [ON]/[OFF] by pressing the assigned function button. If you press [DISP.] button while the screen is displayed, you can change the settings for Snap Movie.
- [Snap Movie] will be set to [OFF] when you connect to Wi-Fi with [Remote Shooting & View].
- This function is not available in the following cases:
  - [Miniature Effect] (Creative Control Mode)
  - When [4K PHOTO] is set
  - When [Post Focus] is set
  - When [4K Live Cropping] is set
  - When recording with [High Speed Video]

## Setting up [Pull Focus]

Set the frames that specify the positions where the [Pull Focus] starts (first position) and stops (second position).

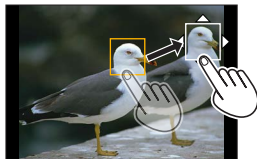





### Touch operation

Touch a subject (first position), drag your finger to the desired location (second position), and release the finger.



- To cancel the frame settings, touch .

### Button operation

- ① Assign [AF Mode] to a function button ([Fn1] - [Fn3]) ([→48](#))
- ② Press the function button that [AF Mode] has assigned to at step ①
- ③ Press     to move the frame, and press [MENU/SET] (First position)
  - If you press [DISP.] button before pressing [MENU/SET], the frame will return to the center.
- ④ Repeat step ③ (Second position)
  - To cancel the frame settings, press [MENU/SET].



- A greater effect can be achieved by creating a striking contrast of focus between the start and end positions, for example by shifting focus from the background to foreground, or vice versa.
- After setting focus, try to keep the distance between the subject and the camera constant.

- When the camera fails to set the frame, it returns to the first position.
- When [Pull Focus] is set to [ON]
  - Auto Focus Mode will be switched to , a setting specially designed for [Pull Focus].
  - If you take a picture, the Auto Focus operation  will take place at the first frame position.
- When [Metering Mode] is set to  (Spot), the spot metering target is fixed at the start position (first position) of [Pull Focus].
- This function is not available in the following cases:
  - In Manual Focus
  - When using the Digital Zoom

## Viewing your pictures

### 1 Press [▶] (Playback) button

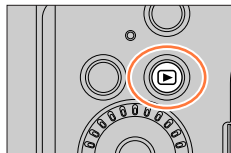

### 2 Press ◀▶ to select a picture to be displayed

- When you press and hold ◀▶, the pictures are displayed one after another.
- Pictures can also be forwarded or rewound by rotating the control dial or dragging the screen horizontally.
- You can forward or rewind pictures continuously by keeping your finger on the left or right sides of the screen after forwarding/rewinding a picture. (The pictures are displayed in a reduced size.)



### ■ Ending Playback

Press [▶] (Playback) button again.

The Playback can also be ended by pressing the shutter button halfway.

- By holding down [▶] (Playback) button while the camera is off, you can turn the camera on in playback mode.
- When [Lens Retraction] is set to [ON], the lens barrel is retracted after approx. 15 seconds as the camera is switched to the playback screen from the recording screen.
- This camera is compliant with the unified DCF (Design rule for Camera File system) standard formulated by the Japan Electronics and Information Technology Industries Association (JEITA), and with Exif (Exchangeable image file format). Files that are not DCF-compliant cannot be played back.
- It may not be possible to properly play back pictures taken using other cameras on this unit or it may not be possible to use the functions of this unit for those pictures.

## Viewing motion pictures

This unit was designed to play motion pictures using the MP4 format.

- Motion pictures are displayed with the motion picture icon ([]).

### 1 Press to start playback













 Motion picture recording time

- Touching [] in the middle of the screen allows you to play back motion pictures.
- Motion pictures recorded with [Snap Movie] are played back automatically.







### ■ Operations during motion picture playback

Operation	Touch operation	Description
		Play / pause
		Fast rewind*
		Single-frame rewind (while paused)
		Fast forward*
		Single-frame forward (while paused)
		Stop
		Volume down / Volume up

\* The fast forward or rewind speed increases if you press  again.

### ■ Operations during automatic Snap Movie playback

	Playback from the beginning
	Returning to the previous picture
	Scrolling to the next picture

- If you touch the screen, automatic playback will stop.

● Motion pictures can be viewed on your computer using "PHOTOfunSTUDIO".

## Capturing still pictures from motion pictures

### 1 Display the picture that you want to capture as a still picture by pressing **▲** to pause a motion picture being played back on the camera

- If you press **◀▶** while paused, you can make finer adjustments to the positions in a motion picture.



### 2 Press [MENU/SET]

- The same operation can be performed by touching [**⏏**].
- The still picture is saved with aspect ratio of [16:9] and [Quality] of [**⏏**]. The picture size varies depending on the motion picture being played back.

[Rec Quality]	[Picture Size]
[4K]	[M] (8M)
[FHD], [HD]	[S] (2M)

- The picture quality becomes slightly lower depending on the [Rec Quality] setting of the original motion picture.
- When a still picture captured from a motion picture is played back, [**⏏**] is displayed.

## Switching the Playback Method

### Zooming in and viewing “Playback Zoom”

#### 1 Move the zoom lever toward T side

Ⓐ Current zoom position

- Each time you move the zoom lever toward the T side, the magnification increases through four levels: 1x, 2x, 4x, 8x, and 16x.

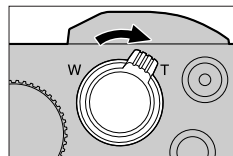

Operation	Touch operation	Description
	—	Enlarges/reduces the screen in large steps.
—	Pinch out / Pinch in	Enlarges/reduces the screen in small steps.
	Drag	Moves the enlarged area (during enlarged display).
	—	Forwards/rewinds a picture while maintaining the same zoom magnification and zoom position (during enlarged display).

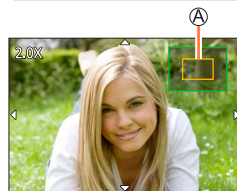

- You can also zoom in by quickly touching the display twice. (If the display was enlarged, it returns to the same magnification ratio.)

- Pictures recorded with [Quality] set to [RAW] can be enlarged up to 8x.

## Switching the Playback Method

## Viewing a list of pictures “Multi Playback”

## 1 Move the zoom lever toward W side

- Move the zoom lever toward the W side and you can switch the display methods in the following order: 1-picture screen (full-screen) → 12-picture screen → 30-picture screen → Calendar screen. (Move the lever to the T side to return.)
- It is possible to switch the playback screen by touching the following icons.
  - [■]: 1-picture screen      – [📅]: 12-picture screen
  - [📄]: 30-picture screen    – [CAL]: Calendar screen (→162)
- The screen can be switched gradually by dragging the screen up or down.
- When you select a picture using the cursor button and press [MENU/SET] on the 12-picture or 30-picture screen, the selected picture is displayed on the 1-picture screen (full-screen). (When you select a motion picture, it is automatically played back.)

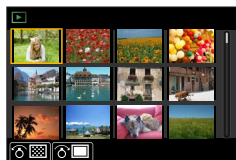
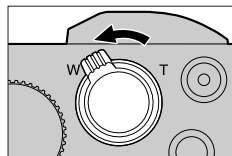

- Pictures displayed with [!] cannot be played back.

## Viewing pictures by their recording date “Calendar Playback”

## 1 Move the zoom lever toward the W side to display the calendar screen

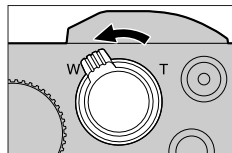

## 2 Use ▲▼◀▶ to select recording date and press [MENU/SET]

Ⓐ Selected date

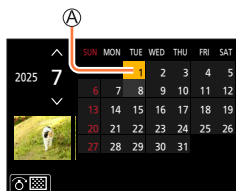

- Pictures are displayed in a 12-picture screen.
- Turn the zoom lever toward the W side to return to the Calendar screen display.



- You can display the calendar between January 2000 to December 2099.
- Pictures taken without clock settings are displayed with the date 1st January, 2025.
- Pictures taken with destination settings made in [World Time] are displayed in the calendar screen using the appropriate date for the destination's time zone.

## Viewing group pictures

You can consecutively play back multiple pictures in a group or play back group pictures one by one.



	Group picture saved using [4K PHOTO Bulk Saving]
	Group pictures recorded using [Time Lapse Shot]
	Group pictures recorded using [Stop Motion Animation]









- You can delete or edit pictures in group units. (For example, if you delete one of pictures in a group, all pictures in that group will be deleted.)
- Pictures will not be grouped if they are recorded without setting [Clock Set].

## Playing back group pictures consecutively

### 1 Press ▲

- The same operation can be performed by touching the group picture icon (, , ).
- When you play back group pictures one by one, the option settings are displayed. After you select [Burst Play] (or [Sequential Play]), select one of the following playback methods.  
 [From the first picture]: Play back the group pictures consecutively from the first picture in a group.  
 [From the current picture]: Play back the group pictures consecutively from the picture currently played back.

### ■ Operations during continuous playback

Operation	Touch operation	Description	Operation	Touch operation	Description
▲		Continuous playback / Pause	▼		Stop
◀		Fast rewind playback	▶		Fast forward playback
		Returning to the previous picture (while paused)			Scrolling to the next picture (while paused)

## Playing back group pictures one by one

### 1 Press ▼

- The same operation can be performed by touching [⏮] / [⏪] / [⏩] / [⏭].

### 2 Use ◀▶ to scroll through the pictures



- Pressing ▼ again or touching [⏮] will return you to the normal playback screen.
- You can use the same operations for pictures stored in a group as in normal still picture playback. (Multi Playback, Playback Zoom, deletion of pictures, etc.)



## Deleting pictures

Deleted pictures cannot be recovered.

### [Delete Single]

- 1 Press [  ] button to delete displayed picture
  - The same operation can be performed by touching [  ].

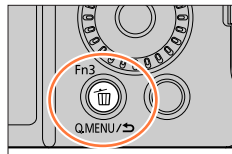

- 2 Use ▲ to select [Delete Single] and press [MENU/SET]

### To delete multiple (up to 100\*)/To delete all pictures

\* A picture group is handled as 1 picture. (All the pictures in the selected picture group are deleted.)

- 1 Press [  ] button while viewing a picture
- 2 Use ▲ ▼ to select [Delete Multi]/[Delete All] and press [MENU/SET]
  - You can select [Delete All Non-rating] in [Delete All] if there are pictures that have been set as [Rating].

(When [Delete Multi] is selected)

- 3 Use ▲ ▼ ◀ ▶ to select picture and press [MENU/SET] (repeat)

 Picture selected

- To cancel → Press [MENU/SET] again.

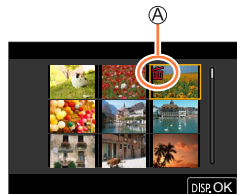

- 4 Press [DISP.] button to execute
  - May take time depending on number of pictures deleted.

## Menu list

### Menus to be displayed in each recording mode

#### [Intelligent Auto]

- [Intelligent Auto Mode] ([→53](#))
- [iHandheld Night Shot] ([→55](#))
- [iHDR] ([→56](#))

#### [Creative Video]

- [Exposure Mode] ([→81](#))
- [High Speed Video] ([→82](#))
- [4K Live Cropping] ([→84](#))

#### **C** [Custom Mode]

You can select your preferred custom setting from [C1], [C2-1], [C2-2] and [C2-3]. ([→87](#))

#### [Scene Guide]

- [Scene Switch] ([→71](#))

#### [Creative Control]

- [Filter Effect] ([→75](#))
- [Simultaneous Record w/o Filter] ([→75](#))

[Rec]	<a href="#">→167</a>
-------	----------------------

[Motion Picture]	<a href="#">→179</a>
------------------	----------------------

[Custom]	<a href="#">→181</a>
----------	----------------------

[Setup]	<a href="#">→195</a>
---------	----------------------

[My Menu]	<a href="#">→205</a>
-----------	----------------------

[Playback]	<a href="#">→206</a>
------------	----------------------

**[Rec]**

- [Aspect Ratio] (→167)
- [Picture Size] (→168)
- [Quality] (→168)
- [AFS/AFF/AFC]\* (→89)
- [Sensitivity]\* (→105)
- [White Balance] (→107)
- [AF Mode]\* (→90)
- [Photo Style]\* (→169)
- [Filter Settings]\* (→171)
- [Metering Mode]\* (→173)
- [i.Dynamic]\* (→174)
- [i.Resolution]\* (→174)
- [Flash Adjust.] (→148)
- [ISO Auto Upper Limit (Photo)] (→175)
- [Min. Shtr Speed] (→175)
- [Diffraction Compensation]\* (→176)
- [Stabilizer]\* (→139)
- [i.Zoom]\* (→142)
- [Digital Zoom]\* (→143)
- [Burst Rate] (→112)
- [4K PHOTO] (→114)
- [Self Timer] (→130)
- [Time Lapse Shot] (→131)
- [Stop Motion Animation] (→134)
- [Silent Mode] (→176)
- [Shutter Type] (→177)
- [Bracket] (→137)
- [HDR] (→178)

\* Menu items are common for both [Rec] and [Motion Picture] menus. If a setting in one menu is changed, the setting with the same name in other menu will also be changed automatically.

**[Aspect Ratio]**

Recording mode:   **P** **A** **S** **M**   

You can select the image aspect ratio.

**MENU** →  **[Rec]** → **[Aspect Ratio]**

<b>[4:3]</b>	Aspect ratio of a 4:3 TV
<b>[3:2]</b>	Aspect ratio of standard film cameras
<b>[16:9]</b>	Aspect ratio of high-definition TV, etc.
<b>[1:1]</b>	Aspect ratio of a square image

**[Picture Size]**Recording mode: **P** **A** **S** **M**

Sets the picture's image size.

**MENU** → **[Rec]** → **[Picture Size]**

[Aspect Ratio]	4:3	3:2	16:9	1:1
[Picture Size]	<b>[L] 20M</b> 5184×3888	<b>[L] 17M</b> 5184×3456	<b>[L] 14.5M</b> 5184×2920	<b>[L] 14.5M</b> 3888×3888
	<b>[EX M] 10M</b> 3712×2784	<b>[EX M] 9M</b> 3712×2480	<b>[EX M] 8M</b> 3840×2160	<b>[EX M] 7.5M</b> 2784×2784
	<b>[EX S] 5M</b> 2624×1968	<b>[EX S] 4.5M</b> 2624×1752	<b>[EX S] 2M</b> 1920×1080	<b>[EX S] 3.5M</b> 1968×1968

- The picture size will be fixed to [4K] when recording 4K photos or recording in [Post Focus].

**[Quality]**Recording mode: **P** **A** **S** **M**

Set the compression rate used for storing pictures.

**MENU** → **[Rec]** → **[Quality]**

Settings	File format	Description
	JPEG	Gives priority to picture quality and saves pictures in JPEG file format.
		Saves pictures in JPEG file format using standard picture quality. This setting is useful when you want to increase the number of recordable pictures without changing the number of pixels.
<b>[RAW]</b>	RAW + JPEG	Saves pictures in both RAW and JPEG file format ( or ) simultaneously.
<b>[RAW]</b>		
<b>[RAW]</b>	RAW	Saves pictures in RAW file format.



## About RAW file

In RAW file format the data is saved without any picture processing by the camera. To play back and edit RAW file pictures, you must use this unit or dedicated software.

- You can develop the RAW file pictures using [RAW Processing] in the [Playback] menu. (→211)
- To develop and edit RAW file pictures on a PC, use the software (Adwaa's "SILKYPIX Developer Studio"). To get this software, download it from the supplier's website and install it on your PC. (→254)

- A RAW still picture is always recorded at [4:3] (5184×3888).
- If you delete a picture recorded in [RAW] or [RAW.L] from the camera, the corresponding RAW and JPEG pictures are also deleted.
- When you play back a picture recorded with [RAW], the gray area is displayed according to the aspect ratio of the picture during recording.
- The setting is fixed to [RAW] when recording 4K photos or recording in [Post Focus].
- You cannot set to [RAW], [RAW.L] or [RAW] in the following case:
  - [Handheld Night Shot] (Scene Guide Mode)

## [Photo Style]

Recording mode:

You can adjust the colors and picture quality according to the concept of the picture that you want to create.

**MENU** → [Rec] / [Motion Picture] → [Photo Style]

<b>STD.</b> [Standard]	Standard setting.
<b>VIVID</b> [Vivid]	Setting with slightly high contrast and saturation.
<b>NAT</b> [Natural]	Setting with slightly low contrast.
<b>MONO</b> [Monochrome]	Setting that creates a picture using monochrome shades of gray only, such as black and white.
<b>SCNY</b> [Scenery]	Setting that creates a picture using vivid colors for the blue sky and green.
<b>PORT</b> [Portrait]	Setting that produces the look of a healthy complexion.
<b>CUST</b> [Custom]	Setting for using colors and picture quality that were registered in advance.

- In Intelligent Auto Plus Mode:
  - Only [Standard] or [Monochrome] can be set.
  - The setting resets to [Standard] when the camera is switched to another recording mode or turned on/off.
  - Picture quality cannot be adjusted.
- Only picture quality adjustment can be set in the Scene Guide Mode. (→170)

## ■ Adjusting the picture quality

- ① Press ◀▶ to select the type of Photo Style
- ② Press ▲▼ to select an item and press ◀▶ to adjust

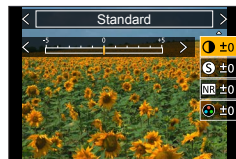

ⓘ [Contrast]	[+]	Increases the contrast in a picture.
	[-]	Decreases the contrast in a picture.
Ⓢ [Sharpness]	[+]	Enhances the outlines in a picture.
	[-]	Softens the outlines in a picture.
NR [Noise Reduction]	[+]	Increases the noise reduction effect to reduce noise. This setting may slightly lower the resolution.
	[-]	Lowers the noise reduction effect to achieve a picture quality with clearer resolution.
🌈 [Saturation]*1	[+]	Gaudy coloring
	[-]	Subdued coloring
🌈 [Color Tone]*1	[+]	Bluish coloring
	[-]	Yellowish coloring
🎛️ [Filter Effect]*2	[Yellow]	Enhances the contrast of a subject. (Effect: Low) Records a blue sky clearly.
	[Orange]	Enhances the contrast of a subject. (Effect: Medium) Records a blue sky with vibrant colors.
	[Red]	Enhances the contrast of a subject. (Effect: High) Records a blue sky with even more vibrant colors.
	[Green]	Applies subdued coloring for the skin and lips of a person. Emphasizes green leaves and makes them brighter.
	[Off]	—

\*1 [Color Tone] is displayed only when [Monochrome] is selected. Otherwise, [Saturation] is displayed.

\*2 Displayed only when [Monochrome] is selected.

• When the picture quality is adjusted, [+] will be displayed in the [Photo Style] icon.

- ③ Press [MENU/SET]

## ■ Registering the setting for the adjusted picture quality to [Custom]

- ① Perform the picture quality adjustment in Step ② of “Adjusting the picture quality” and press the [DISP.] button

## [Filter Settings]

Recording mode: **PAS** SCN

You can apply picture effects (filters) that are available for Creative Control Mode to images in other modes, such as Aperture-Priority AE Mode. (→75)

**MENU** → **[Rec]** / **[Motion Picture]** → **[Filter Settings]** → **[Filter Effect]**

Settings: **[ON]** / **[OFF]** / **[SET]**

### ■ With touch screen operations

- ① Touch
- ② Touch the item you want to set
  - : Picture effects ON or OFF
  - : Picture effects (Filter)
  - : Adjusting the picture effect

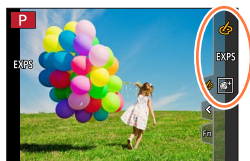



- [Rough Monochrome], [Silky Monochrome], [Soft Focus], [Star Filter] and [Sunshine] are not available in the following cases.
  - Creative Video Mode
  - During motion picture recording
- The available ISO sensitivity settings will be limited up to [3200].
- The ISO sensitivity for [High Dynamic] will be fixed to [AUTO].
- When using [Filter Effect], you cannot use menus or recording functions which are not available in Creative Control Mode.
- This function is not available in the following cases:
  - When recording with [High Speed Video]
  - When recording using [4K Live Cropping]

### ■ Taking two still pictures with and without picture effects ([Simultaneous Record w/o Filter])

You can take two still pictures at the same time by pressing the shutter button once; one with effects and one without effects.

**MENU** →  [Rec] /  [Motion Picture] → [Filter Settings]  
→ [Simultaneous Record w/o Filter]

#### Settings: [ON] / [OFF]

- The camera will take a still picture with the effects applied and then a still picture without the effects.
  - After taking the picture, [Auto Review] will display only the still picture with the effects applied.
- This function is not available in the following cases:
- When using [Burst]
  - When recording 4K photos
  - When recording using [Post Focus]
  - Taking still pictures while a motion picture is being recorded
  - When [Quality] is set to [RAW , [RAW ] or [RAW]
  - When recording using [Bracket]
  - When using [Time Lapse Shot]
  - When using [Stop Motion Animation]

## [Metering Mode]

Recording mode: **PAS** **M**

You can change the metering method used for measuring brightness.

**MENU** → **[Rec]** / **[Motion Picture]** → **[Metering Mode]**

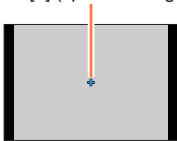
[Metering Mode]	Brightness measurement position	Conditions
 (Multiple)	Whole screen	Normal usage (produces balanced pictures)
 (Center weighted)	Center and surrounding area	Subject in center
 (Spot)	Center of [+] (spot metering target) 	Great difference between brightness of subject and background (e.g. person in spotlight on stage, backlighting)

- If you set the spot metering target on the edge of the screen, the metering may be affected by the brightness around the location.

**[i.Dynamic]**

**Recording mode:**   **PAS** **M**  **SCN** 

Automatically adjusts contrast and exposure to give more lifelike colors when there is significant contrast between background and subject.

**MENU** →  **[Rec]** /  **[Motion Picture]** → **[i.Dynamic]**

**Settings:** **[AUTO]** / **[HIGH]** / **[STANDARD]** / **[LOW]** / **[OFF]**

- You may not see the effect depending on the recording conditions.
- This function is not available in the following cases:
  - When **[HDR]** is set to **[ON]**
  - When **[Sensitivity]** is set to **[H.4000]**, **[H.5000]** or **[H.6400]**

**[i.Resolution]**

**Recording mode:**   **PAS** **M**  **SCN** 

You can use the camera's Intelligent Resolution technology to record still pictures with sharper outlines and clearer resolution.

**MENU** →  **[Rec]** /  **[Motion Picture]** → **[i.Resolution]**

**Settings:** **[HIGH]** / **[STANDARD]** / **[LOW]** / **[OFF]**

**[ISO Auto Upper Limit (Photo)]**

Recording mode:   **P** **A** **S** **M**   

You can set the upper limit of ISO sensitivity when ISO sensitivity is set to [AUTO] or [B]iso.

**MENU** →  **[Rec]** → **[ISO Auto Upper Limit (Photo)]**

Settings: **[AUTO]** / **[200]** / **[400]** / **[800]** / **[1600]** / **[3200]**

- [ISO Auto Upper Limit (Photo)] cannot be set in the following cases:
  - [Clear Nightscape], [Cool Night Sky], [Warm Glowing Nightscape], [Artistic Nightscape], [Handheld Night Shot] (Scene Guide Mode)

**[Min. Shtr Speed]**

Recording mode:   **P** **A** **S** **M**   

Sets the minimum value for the shutter speed to be used when ISO sensitivity is set to [AUTO] or [B]iso.

**MENU** →  **[Rec]** → **[Min. Shtr Speed]**

Settings: **[AUTO]** / **[1/16000]** to **[1/1]**

- The shutter speed may be slower than the setting value under recording conditions in which the correct exposure is not achieved.

## [Diffraction Compensation]

Recording mode: **P** **A** **S** **M**

The camera raises the resolution by correcting the blurriness caused by diffraction when the aperture is closed.

**MENU** → **[Rec]** / **[Motion Picture]** → **[Diffraction Compensation]**

Settings: **[AUTO]** / **[OFF]**

- Noise in the periphery of the picture may stand out with higher ISO sensitivity.

## [Silent Mode]

Recording mode: **P** **A** **S** **M**

Disabling the beeps and flash at the same time.

**MENU** → **[Rec]** → **[Silent Mode]**

Settings: **[ON]** / **[OFF]**

- This mode will mute sounds from the speaker and disable the flash and AF Assist Lamp.

The settings for the following functions are fixed:

- [Flash Mode]: [] (Forced Flash Off)
- [Shutter Type]: [ESHTR]
- [AF Assist Lamp]: [OFF]
- [Beep Volume]: [] (Off)
- [Shutter Vol.]: [] (Off)

- Even when this mode is set to [ON], the following lamps/indicators will light or flash.
  - Self-timer indicator
  - WIRELESS connection lamp
- The operation sounds of this camera such as the lens aperture sound are not muted.

**[Shutter Type]**

Recording mode: **P** **A** **S** **M**

You can take pictures using two types of shutter modes: the mechanical shutter and electronic shutter.

	Mechanical shutter	Electronic shutter
Flash	○	—
Shutter Speed (seconds)	4*1, *2 - 1/2000	1*1 - 1/16000
Shutter sound	Mechanical shutter sound + Electronic shutter sound*3	Electronic shutter sound*3

\*1 Varies depending on the setting of ISO sensitivity. (→105)

\*2 The shutter speed is set to 30 seconds in [Artistic Nightscape] (Scene Guide Mode).

\*3 You can use [Shutter Vol.] and [Shutter Tone] to adjust the volume of the electronic shutter sound. (→197)

**MENU** → **[Rec]** → **[Shutter Type]**

<b>[AUTO]</b>	The shutter mode automatically switches based on the recording conditions and shutter speed. • The mechanical shutter mode has higher priority over the electronic shutter mode because the mechanical shutter has less function-related restrictions when recording with a flash, etc.
<b>[MSHTR]</b>	Uses only the mechanical shutter mode to take a picture.
<b>[ESHTR]</b>	Uses only the electronic shutter mode to take a picture.

- When [E] is displayed on the screen, recording is performed with an electronic shutter.
- If you take a picture of a moving subject using the electronic shutter, the subject in the picture may be skewed in some cases.
- When you take a picture under a fluorescent or LED lighting fixture using the electronic shutter, the recorded picture may have horizontal stripes. If you use a slower shutter speed, the horizontal stripes may be reduced.

**[HDR]**



**Recording mode:**   **PASM**   

The camera can combine 3 still pictures taken at different exposures into a single properly exposed picture with rich gradation. The individual pictures used to create the HDR picture are not saved. You can minimize the loss of gradations in bright areas and dark areas when, for example, the contrast between the background and the subject is large.

A combined HDR picture is saved in JPEG format.

**MENU** →  **[Rec]** → **[HDR]**

**Settings:** **[ON]** / **[OFF]**

- After the shutter button has been pressed, do not move the camera during the burst operation.
- Since a burst of still pictures are combined after they have been recorded, it will be a few moments before you will be able to record another picture.
- A subject that was in motion when it was recorded may be recorded as an afterimage.
- When you take pictures using a flash, the flash mode is fixed to  (Forced Flash Off).
- This function will not work for still pictures while motion pictures are being recorded.
- This function is not available in the following cases:
  - In Self Shot Mode
  - When using [Burst]
  - When recording 4K photos
  - When recording using [Post Focus]
  - When recording using [Bracket]
  - When [Quality] is set to [RAW , [RAW ] or [RAW]
  - When using [Time Lapse Shot]
  - When [Auto Shooting] of [Stop Motion Animation] is set to [ON]

## [Motion Picture]

- [Rec Quality] (→151)
- [Snap Movie] (→155)
- [AFS/AFF/AFC]\* (→89)
- [Continuous AF] (→153)
- [Sensitivity]\* (→105)
- [AF Mode]\* (→90)
- [Photo Style]\* (→169)
- [Filter Settings]\* (→171)
- [Metering Mode]\* (→173)
- [i.Dynamic]\* (→174)
- [i.Resolution]\* (→174)
- [ISO Auto Upper Limit (Video)] (→82)
- [Diffraction Compensation]\* (→176)
- [Stabilizer]\* (→139)
- [Flkr Decrease] (→179)
- [Level Shot] (→179)
- [i.Zoom]\* (→142)
- [Digital Zoom]\* (→143)
- [Wind Noise Canceller] (→180)
- [Zoom Mic] (→180)

\* Menu items are common for both [Rec] and [Motion Picture] menus. If a setting in one menu is changed, the setting with the same name in other menu will also be changed automatically.

## [Flkr Decrease]

Recording mode:   **PAS**M   

The shutter speed can be fixed to reduce the flicker or striping in the motion picture.

**MENU** →  [Motion Picture] → [Flkr Decrease]

Settings: [1/50] / [1/60] / [1/100] / [1/120] / [OFF]

## [Level Shot]

Recording mode:   **PAS**M   

Level Shot function automatically detects the camera's tilt while recording motion pictures, and horizontally corrects the recording motion picture so it will not be tilted.

**MENU** →  [Motion Picture] → [Level Shot]

Settings: [ON] / [OFF]

- If you record while walking, or if the camera's tilt is large, it may not be possible to horizontally correct the motion pictures.
- The angle of view becomes slightly narrow when motion picture recording starts.
- Still pictures taken while recording motion pictures will not be horizontally corrected.
- This function is not available in the following cases:
  - When recording with [High Speed Video]
  - When recording using [4K Live Cropping]
  - When [Stabilizer] is set to [OFF]
- **With camera models DC-ZS99P/DC-ZS99PP/DC-TZ99GD:**  
When recording motion pictures with [Rec Quality] set to [4K/100M/30p]
- **With camera models DC-TZ99E/DC-TZ99GA/DC-TZ99GH/DC-TZ99GN:**  
When recording motion pictures with [Rec Quality] set to [4K/100M/30p] or [4K/100M/25p]

### [Wind Noise Canceller]

Recording mode:   **P** **A** **S** **M**   

This will reduce the wind noise coming into the built-in microphone while maintaining sound quality.

**MENU** →  **[Motion Picture]** → **[Wind Noise Canceller]**

Settings: **[HIGH]** / **[STANDARD]** / **[OFF]**

- **[HIGH]** effectively reduces the wind noise by minimizing the low-pitched sound when a strong wind is detected.
- **[STANDARD]** extracts and reduces only the wind noise without deteriorating the sound quality.
- You may not see the full effect depending on the recording conditions.

### [Zoom Mic]

Recording mode:   **P** **A** **S** **M**   

Coupled to the zoom operation, it will more clearly record far sounds during enlarging image, and surrounding sounds with wide-angle.

**MENU** →  **[Motion Picture]** → **[Zoom Mic]**

Settings: **[ON]** / **[OFF]**

- When set to **[ON]** and performing zoom, the operation sound may be recorded enhanced in accordance with the surrounding sounds. Also, audio recording level will be lower compared to when **[OFF]**.
- The stereo effect of the audio is reduced during enlarging image.

**[Custom]** **[Exposure]**

- [ISO Increments] (→182)
- [Extended ISO] (→182)
- [Exposure Comp. Reset] (→182)

 **[Focus / Release Shutter]**

- [AF/AE Lock] (→103)
- [AF/AE Lock Hold] (→182)
- [Shutter AF] (→182)
- [Half Press Release] (→182)
- [Quick AF] (→182)
- [Pinpoint AF Setting] (→183)
- [AF Assist Lamp] (→183)
- [Direct Focus Area] (→183)
- [Focus/Release Priority] (→184)
- [AF+MF] (→184)
- [MF Assist] (→184)
- [MF Assist Display] (→184)

 **[Operation]**

- [Fn Button Set] (→48)
- [Exposure Comp. Disp. Setting] (→185)
- [Ring/Dial Set] (→51)
- [Operation Lock Setting] (→185)
- [Touch Settings] (→185)
- [Dial Guide] (→186)
- [Zoom lever] (→186)
- [Zoom Compose Assist] (→36)

 **[Monitor / Display]**

- [Auto Review] (→186)
- [Monochrome Live View] (→187)
- [Peaking] (→187)
- [Histogram] (→188)
- [Guide Line] (→188)
- [Center Marker] (→188)
- [Highlight] (→189)
- [Zebra Pattern] (→189)
- [Expo.Meter] (→190)
- [MF Guide] (→190)
- [Rec Area] (→190)
- [Remaining Disp.] (→190)
- [Red REC Frame Indicator] (→191)
- [Menu Guide] (→191)

 **[Lens / Others]**

- [Lens Position Resume] (→191)
- [Lens Retraction] (→191)
- [Self Timer Auto Off] (→191)
- [Self Shot] (→191)
- [Vertical Position Info (Video)] (→191)
- [Face Recog.] (→192)
- [Profile Setup] (→194)

MENU →  [Custom] →  [Exposure]

### [ISO Increments]

You can change the setting to increase ISO sensitivity by 1 EV or 1/3 EV.

### [Extended ISO]

You can extend the numeric values that can be set for ISO Sensitivity. (→105)

### [Exposure Comp. Reset]

If the recording mode is changed or the camera is turned off, the exposure compensation value setting is reset.

MENU →  [Custom] →  [Focus / Release Shutter]

### [AF/AE Lock Hold]

Focus and exposure stays locked even if you press and release the function button where [AF/AE LOCK] is registered. Press the button again to cancel the lock.

### [Shutter AF]

Set whether or not the focus is adjusted automatically when the shutter button is pressed halfway.

### [Half Press Release]

The shutter will immediately fire when the shutter button is pressed halfway.

### [Quick AF]

The focus is automatically adjusted when camera blurring is small even when the shutter button is not pressed. (Increases battery consumption.)

- This function is not available in the following cases:
  - Preview Mode
  - When the lighting is low

**MENU** →  **[Custom]** →  **[Focus / Release Shutter]**

### [Pinpoint AF Setting]

<b>[Pinpoint AF Time]</b>	Sets the time for which the screen is enlarged when the shutter button is pressed halfway with Auto Focus Mode set to <b>[+]</b> .
<b>[Pinpoint AF Display]</b>	Sets whether to display the enlarged screen that appears when Auto Focus Mode is set to <b>[+]</b> in a window or full screen.







### [AF Assist Lamp]

Illuminates the AF Assist Lamp when the shutter button is pressed halfway when it is too dark to facilitate focusing.

- The AF Assist Lamp has an effective distance of 1.5 m (4.9 feet).
- The setting is fixed to [OFF] in the following cases:
  - [Distinct Scenery], [Bright Blue Sky], [Romantic Sunset Glow], [Vivid Sunset Glow], [Glistening Water], [Clear Nightscape], [Cool Night Sky], [Warm Glowing Nightscape], [Artistic Nightscape], [Handheld Night Shot] (Scene Guide Mode)
  - When [Silent Mode] is set to [ON]

### [Direct Focus Area]

Moves the AF area or MF assist using the cursor button while recording.

- When , , , or  is selected, you can move the AF area, when  is selected, you can move the lock start position, and when  is selected, you can move the focus position.
- Perform the setting of functions assigned to the cursor buttons using the Quick menu ([→47](#)) or function buttons ([→48](#)).
- [Direct Focus Area] is fixed to [OFF] in the following cases:
  - [Glistening Water] (Scene Guide Mode)
  - Creative Control Mode
  - When recording using [4K Live Cropping]

**MENU** →  **[Custom]** →  **[Focus / Release Shutter]**

### [Focus/Release Priority]

You can set whether to give higher priority to focusing or shutter release timing when you take pictures using Auto Focus mode.

You can set the priority for each focus mode ([AFS/AFF], [AFC]) separately.

<b>[FOCUS]</b>	No picture is taken unless focusing is achieved.
<b>[BALANCE]</b>	A picture is taken with an appropriate balance between focusing and shutter release timing.
<b>[RELEASE]</b>	A picture is taken even if the subject is out of focus.

### [AF+MF]

You can manually perform fine focusing during AF Lock (pressing the shutter button halfway when [AFS/AFF/AFC] in [Rec] menu is set to [AFS] or setting AF Lock using the [AF/AE LOCK]).

### [MF Assist]

Displays the MF Assist (enlarged screen) during Manual Focus in order to facilitate focusing.

- MF Assist is not displayed in the following cases:
  - During motion picture recording
  - When recording with  ([4K Pre-Burst]) of the 4K Photo function
  - When using the Digital Zoom

### [MF Assist Display]

Sets whether to display the MF Assist (enlarged screen) in a window or full screen.

MENU →  [Custom] →  [Operation]

### [Exposure Comp. Disp. Setting]

#### ■ [Cursor Buttons (Up/Down)]

Set a function to assign to ▲ ▼ on the exposure compensation screen.

Settings: [] ([Exposure Bracket]) / [OFF]

### [Operation Lock Setting]

You can set an object for which operation is disabled when [Operation Lock] is assigned to the function button using [Fn Button Set] (→48) in the [Custom] ([Operation]) menu.

[Cursor]	Disables the operation of the cursor button and [MENU/SET] button.
[Touch Screen]	Disables the touch operation using the touch panel.
[Dial]	Disables the operation of the control dial, front dial and control ring.

### [Touch Settings]

Enabling/disabling the touch operation.

[Touch Screen]	All touch operations.
[Touch Tab]	Operations of tabs, such as [  ] displayed on the right side of the screen.
[Touch AF]	Operation to optimize the focus [AF] or both the focus and brightness [AF+AE] for a touched subject.

MENU →  [Custom] →  [Operation]

### [Dial Guide]

You can display the operation guide when switching recording modes.





Example

### [Zoom lever]

Changing the zoom operation settings.

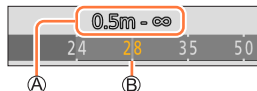
Q (Zoom)	The zoom operates in the normal way.
Q (Step Zoom)	<p>Each time zoom is operated, the zoom stops at the position for one of the preset focal lengths.</p> <p>Ⓐ Focus range Ⓑ Current zoom position</p> <ul style="list-style-type: none"> <li>This setting does not work when recording motion pictures or 4K photos with  ([4K Pre-Burst]).</li> </ul>





MENU →  [Custom] →  [Monitor / Display]

### [Auto Review]

[Duration Time (photo)]	Set the time to display the pictures you have taken after taking still pictures.
[Duration Time (4K PHOTO)]	Set whether to display the pictures you have taken after recording 4K photos.
[Duration Time (Post Focus)]	Set whether to display the pictures you have taken after recording using [Post Focus].
[Playback Operation Priority]	Allows you to switch the playback screen or to delete pictures when the [Auto Review] function is activated.

- When [Duration Time (photo)] is set to [HOLD], pictures are displayed until you press the shutter button halfway. In this case, [Playback Operation Priority] is fixed to [ON].

MENU →  [Custom] →  [Monitor / Display]

## [Monochrome Live View]

You can display the recording screen in black and white.

- When using the HDMI output during recording, the image is not displayed in black and white.
- This does not affect recorded pictures.



## [Peaking]

When you perform Manual Focus operation, this function automatically adds color to the portions of the image that are in Focus (portions on the screen with clear outlines).

- When [Detect Level] in [SET] is set to [HIGH], portions to be highlighted are reduced, allowing you to achieve a more precise focus.
- Changing the [Detect Level] setting also changes the [Display Color] setting as follows.

[Detect Level]	[HIGH]	↔	[LOW]
[Display Color]	 (Light blue)	↔	 (Blue)
	 (Yellow)	↔	 (Orange)
	 (Yellow Green)	↔	 (Green)
	 (Pink)	↔	 (Red)
	 (White)	↔	 (Gray)

- Each time [PEAK] in [] is touched, the setting is switched in order of [PEAK L] ([Detect Level]: [LOW]) → [PEAK H] ([Detect Level]: [HIGH]) → [OFF].
- This function is not available in the following case:
  - [Rough Monochrome] (Creative Control Mode)

MENU →  [Custom] →  [Monitor / Display]

## [Histogram]

You can display the histogram.

When set to [ON], you can move the display position of the histogram by pressing ▲▼◀▶.

- Direct touch operation is also possible from the recording screen.

Displays distribution of brightness in picture – e.g. if the graph peaks at the right, this means there are several bright areas in the picture. A peak in the center represents correct brightness (correct exposure). This can be used as a reference for exposure correction, etc.

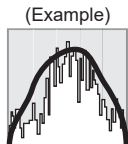



Dark ← OK → Bright

- **When the histogram is not the same as that of the recorded picture under the following conditions, histogram will be displayed in orange:**
  - During Exposure Compensation.
  - When the flash fires.
  - When the correct exposure is not achieved, such as when the lighting is low.



## [Guide Line]

Sets the pattern of the guidelines to be displayed while recording.

- When you select , you can move the position of the guideline by pressing ▲▼◀▶.
- You can also set the position directly by touching  on the guideline of the recording screen.

## [Center Marker]

A cross [+ ] is displayed to indicate the center of the recording screen.

**MENU** →  **[Custom]** →  **[Monitor / Display]**

### [Highlight]

You can set overexposed areas to flash on the screen when the [Auto Review] function is activated or during playback.

- To reduce overexposed areas, record a picture by setting negative exposure compensation using the histogram display and so on as a reference.
- This feature is disabled during 4K photo playback, playback of pictures recorded in [Post Focus], Multi Playback, Calendar Playback, or Playback Zoom.
- This does not affect recorded pictures.



### [Zebra Pattern]

You can check the area in a picture, which could result in overexposure, by displaying such an area using a zebra pattern.

**[ZEBRA1]:**





**[ZEBRA2]:**



Select [SET] to set the brightness to be displayed for each zebra pattern.

- The range of brightness you can select from is [50%] to [105%]. The [OFF] setting is available for [Zebra 2]. When [100%] or [105%] is selected, only the overexposed areas are displayed with the zebra pattern. When a smaller numeric value is set, the range of brightness to be displayed by each zebra pattern will increase.

- To reduce overexposed areas, record a picture by setting negative exposure compensation using the histogram display and so on as a reference.
- The displayed zebra pattern is not recorded.
- When [Zebra Pattern] is assigned to the function button using [Fn Button Set] ([→48](#)) in the [Custom] ([Operation]) menu, every time you press the assigned function button, the setting will switch in the following order: [Zebra 1] → [Zebra 2] → [Zebra OFF]. When [Zebra 2] is set to [OFF], you can switch the setting quickly in the following order: [Zebra 1] → [Zebra OFF].

MENU →  [Custom] →  [Monitor / Display]

### [Expo.Meter]

You can display the exposure meter.

 Exposure meter

- When you set this function to [ON], an exposure meter is displayed during Program Shift, aperture setting, and shutter speed setting.
- Proper exposure is not possible in the range indicated in red.
- If the exposure meter is not displayed, press the [DISP.] button to switch the display of the monitor.
- The exposure meter will turn off if no operation is performed for approximately 4 seconds.

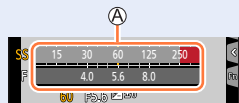

### [MF Guide]

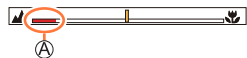

The MF guide is displayed during Manual Focus. You can check whether the point of focus is to the near side or the far side.

 Indicator for ∞ (infinity)



### [Rec Area]



Switching the angle of view setting used for recording still pictures and motion pictures.

	Indicated as the angle of view when recording still pictures.
	Indicated as the angle of view when recording motion pictures.

- The recording area indicated is an approximation.
- [Rec Area] is fixed to  when recording 4K photos or recording in [Post Focus].

### [Remaining Disp.]

Switching the display between the number of recordable pictures that you can take and the available recording time.



**MENU** →  [Custom] →  [Monitor / Display]

### [Red REC Frame Indicator]

A red frame is displayed on the recording screen that indicates that video is being recorded.

### [Menu Guide]

You can display the selection screen when the mode dial is switched to [SCN]/.

**MENU** →  [Custom] →  [Lens / Others]

### [Lens Position Resume]

Remember the zoom position and focus position when the camera is turned off.

### [Lens Retraction]

Sets whether or not to retract the lens barrel a little while after the playback screen appears.

### [Self Timer Auto Off]

The self-timer is canceled if the unit is turned off.



### [Self Shot]

If this is set to [OFF], the camera will not switch to Self Shot Mode (→58) even if you rotate the monitor.

### [Vertical Position Info (Video)]

Records vertical orientation information during video recording. Videos recorded with the camera held vertically will be automatically played vertically on the PC or smartphone etc. during playback.

- On the playback screen of the camera, only the thumbnail display is played in vertical orientation.

**MENU** →  [Custom] →  [Lens / Others]

## [Face Recog.]

The Face Recognition function recognizes a face similar to a registered face and automatically adjusts focus and exposure for the face with higher priority. Even if a person you want to focus on is standing at the back or corner in a group photo, the camera will automatically recognize the person and record this person's face clearly.

**Settings:** [ON] / [OFF] / [MEMORY]

### ■ How the Face Recognition function works

#### During recording

- The camera recognizes a registered face and adjusts focus and exposure.
- When registered faces that have set names are recognized, the names are displayed (max. 3 people).

#### During playback

- The name and age are displayed.



### ■ Registering face pictures

Up to 6 people's face pictures can be registered along with such information as name and birthdate.

- ① Use ▼ to select [MEMORY] and press [MENU/SET]
- ② Use ▲▼◀▶ to select [New] and press [MENU/SET]

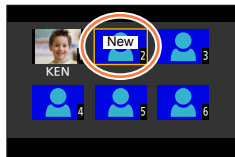

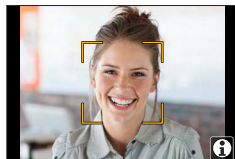

- ③ Align the face with the guide and record
  - Faces of subjects other than people (e.g. pets) cannot be registered.
  - When ► is pressed or [i] is touched, an explanation is displayed.



- ④ Use ▲▼ to select the item for editing and press [MENU/SET]

<b>[Name]</b>	Set the name. • For details on how to enter characters, refer to "Entering Text" (→52)
<b>[Age]</b>	Set the birthdate.
<b>[Add Images]</b>	Up to 3 face pictures of the person can be registered. <ol style="list-style-type: none"> <li>① Use ◀▶ to select [Add] and press [MENU/SET]           <ul style="list-style-type: none"> <li>• When a registered face picture is selected with cursor button, a screen to confirm deletion is displayed. Select [Yes] to delete the face picture.</li> </ul> </li> <li>② Record the picture (step ③)</li> </ol>

**MENU** →  [Custom] →  [Lens / Others]

### ■ Editing or deleting information about registered persons

- ① Use ▼ to select [MEMORY] and press [MENU/SET]
- ② Use ▲▼◀▶ to select the picture of the person to be edited or deleted and press [MENU/SET]
- ③ Use ▲▼ to select the item and press [MENU/SET]

<b>[Info Edit]</b>	Edit name or other registered information. (Step ④ of "Registering face pictures")
<b>[Priority]</b>	Set priority order for focus and exposure. ① Use ▲▼◀▶ to select the registration order and press [MENU/SET]
<b>[Delete]</b>	Delete information and face pictures of registered persons.

### Recording tips when registering face pictures

- Make sure the subject's eyes are open and mouth closed; have the subject face the camera directly, and make sure the outline of the face, the eyes and eyebrows are not hidden by hair.
- Make sure there are no heavy shadows on the face. (During registration, the flash is not used.)

Good example for registering a face





### If the camera seems to have difficulty recognizing faces when recording

- Register additional pictures of the same person's face, indoors and outdoors or with different expressions or angles.
- Register additional pictures at the place you are recording.
- If a registered person is no longer recognized, re-register that person.
- In some cases, the camera cannot recognize or incorrectly recognizes even registered people depending on their expression or the environment.

#### ● [Face Recog.] functions only when Auto Focus mode is set to [AF-ON].

- Only the first picture of the burst recording will contain Face Recognition information.
- The name of the person recognized in the first picture is displayed in the case of group pictures.
- This function is not available in the following cases:
  - [Miniature Effect] (Creative Control Mode)
  - [Slimming Mode] (In Self Shot Mode)
  - During motion picture recording
  - When recording 4K photos
  - When recording using [Post Focus]
  - When using [Time Lapse Shot]

**MENU** →  [Custom] →  [Lens / Others]

## [Profile Setup]

You can set a name or birthday of a baby or pet before taking a picture to record the name or age in months/years in the picture.

Settings: [<sup>1</sup>] ([Baby1]) / [<sup>2</sup>] ([Baby2]) / [] ([Pet]) / [OFF] / [SET]

### ■ Setting the name and age in months/years

- ① Use ▼ to select [SET] and press [MENU/SET]
- ② Use ▲▼ to select [Baby1], [Baby2] or [Pet] and press [MENU/SET]
- ③ Use ▲▼ to select [Age] or [Name] and press [MENU/SET]
- ④ Use ▼ to select [SET] and press [MENU/SET]
  - Enter the [Age].
  - Enter the [Name].
    - For details on how to enter characters, refer to “Entering Text” (→52)

### ■ Canceling the display of the name and age in months/years

Set [Profile Setup] to [OFF].

- [Name] and [Age] print settings can be made on your computer using “PHOTOfunSTUDIO” software, which you download from a website. Text may also be stamped onto the still picture using the camera’s [Text Stamp].
- [Profile Setup] is not available for 4K photo recording or recording in [Post Focus].
- You cannot record the name or age in months/years in the following cases:
  - During motion picture recording
  - Still pictures that are taken while recording motion pictures

## [Setup]

MENU →  [Setup]

- [Cust.Set Mem.] (→86)
- [Clock Set] (→31)
- [World Time] (→195)
- [Travel Date] (→196)
- [Wi-Fi®] (→196)
- [Bluetooth®] (→197)
- [Wireless Connection Lamp] (→197)
- [Beep] (→197)
- [Power Button(At Power ON)] (→198)
- [Power Save Mode] (→198)
- [Monitor Display Speed] (→199)
- [Monitor Display] (→199)
- [Monitor Luminance] (→200)
- [m/ft]\* (→200)
- [TV Connection] (→201)
- [Language] (→202)
- [Version Disp.] (→202)
- [Folder / File Settings] (→202)
- [No.Reset] (→204)
- [Reset] (→204)
- [Reset Network Settings] (→204)
- [Level Gauge Adjust.] (→205)
- [Demo Mode] (→205)
- [Approved Regulations]\* (→205)
- [Format] (→28)

\* Depending on the country or area where the camera was purchased, this is not displayed due to differences in specifications.

## [World Time]

Sets the times for the region where you live and your travel destination.

- You can set [Destination] after setting [Home].

**Settings:** [Destination] / [Home]

**1** Use ▲ ▼ to select [Destination] or [Home] and press [MENU/SET]

**2** Use ◀ ▶ to select area and press [MENU/SET]



When [Destination] has been selected

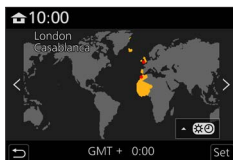

When [Home] has been selected

- Ⓐ Current time at selected destination
- Ⓑ City/area name
- Ⓒ Difference with home time



### ■ To set daylight savings

Press ▲ in step **2**. (Press again to release the setting)

- When daylight savings [☀️] is set, the current time is advanced by 1 hour. If the setting is canceled, the time automatically returns to the current time.

### ■ When you come back from your travel destination

Select [Home] in step **1** and press [MENU/SET].

- Time zones may be revised depending on the country or area, so the place name displayed on the screen may not match the actual time zone. Please also refer to the time difference displayed at the bottom of the screen before setting.

## [Travel Date]

### ■ [Travel Setup]

If you set your travel schedule and record pictures, the day of your trip on which the picture was taken will be recorded.

### ■ To record [Location]

Once the [Travel Setup] is set, you can set the location.

- For details on how to enter characters, refer to “Entering Text” (→52)
- To print [Location] or the number of days that have passed, either use [Text Stamp] (→217) or print using the “PHOTOfunSTUDIO” software.
- The travel date is calculated from the set departure date and the date set in the camera’s clock. When destination is set in [World Time], days elapsed are calculated based on local destination time.
- When [Travel Setup] is set to [OFF], the number of days elapsed is not recorded. It is not displayed even if [Travel Setup] is set to [SET] after recording.
- When the current date passes the return date, [Travel Setup] is automatically canceled.
- [Location] cannot be recorded while recording motion pictures, recording 4K photos, or recording in [Post Focus].

## [Wi-Fi®]

### ■ [Wi-Fi Function] (→246)

### ■ [Wi-Fi Setup] (→248)



## [Bluetooth®]

- [Bluetooth] (→227)
- [Send Image (Smartphone)] (→245)
- [Remote Wakeup] (→232)
- [Auto Transfer] (→237)
- [Location Logging] (→239)
- [Auto Clock Set] (→240)

## [Wireless Connection Lamp]

The lamp lights while the wireless function is operating.

Settings: [ON] / [OFF]

## [Beep]

Sets the beep sounds or shutter sounds.

- [Beep Volume]
- [Shutter Vol.]
- [Shutter Tone]

- When [Silent Mode] is set to [ON], [Beep] is not available.



## [Power Button(At Power ON)]

Sets the operation of the power button when turning on the camera.

<b>[LONG-PRESS]</b>	<p>You can turn on the camera by pressing and holding the camera [ON/OFF] button.</p> <ul style="list-style-type: none"> <li>• Selecting the [LONG-PRESS] setting reduces the risk of the power turning on unintentionally while the camera is in a bag or pocket. (When the camera is turned on, the lens barrel will extend. Applying pressure to the lens barrel can cause it to malfunction.)</li> </ul>
<b>[SHORT-PRESS]</b>	<p>You can turn on the camera by briefly pressing the camera [ON/OFF] button (setting at the time of purchase).</p>

## [Power Save Mode]

### ■ [Auto Power Off]

The camera is automatically turned off if the camera has not been used for the time selected on the setting.

(Selecting the [OFF] setting may increase the power consumption of the camera.)

- When you want to use the camera again, turn the camera back on.

### ■ [Auto Power Off(Wi-Fi)]

The camera is automatically turned off if the camera has not been used for approx.

15 minutes with no Wi-Fi connection. (Selecting the [OFF] setting may increase the power consumption of the camera.)

- When you want to use the camera again, turn the camera back on.

### ■ [Auto Monitor Off]

The monitor is automatically turned off if the camera has not been used for the time selected on the setting.

- To turn the monitor on again, press any button.

● This function is not available in the following cases:

- During motion picture recording/playback
- When recording with [4K Pre-Burst] ([4K Pre-Burst]) of the 4K Photo function
- When connected to computer
- During Slide Shows
- When using [Time Lapse Shot]
- When [Auto Shooting] of [Stop Motion Animation] is set to [ON]
- While the HDMI output is being used for recording.



### [Monitor Display Speed]

Sets the display speed of the monitor.

[ECO 30fps]	Minimizes power consumption and the operating time is extended.
[60fps]	You can display a moving subject in fluid motion. This setting is ideal for recording fast-moving subjects.

- When [Monitor Display Speed] is set to [ECO 30fps], Digital Zoom is not available.
- Cannot set to [ECO 30fps] in the following cases:
  - Creative Video Mode
  - When recording 4K photos
  - When recording using [Post Focus]
- [Monitor Display Speed] is disabled while the HDMI output is being used for recording.
- The [Monitor Display Speed] setting does not affect the recorded picture.

### [Monitor Display]

Adjust brightness and color of the monitor.

[Brightness]	Adjusts the brightness.
[Contrast]	Adjusts the contrast.
[Saturation]	Adjusts the vividness of colors.
[Red Tint]	Adjusts red hues.
[Blue Tint]	Adjusts blue hues.

- Some subjects may look different from their actual appearance, but the recorded picture will not be affected.



### [Monitor Luminance]

Sets the monitor brightness according to the ambient light level.

[A*] (Auto)	During recording, the brightness is adjusted automatically according to how bright it is around the camera. During playback, the brightness is the same as when you last recorded. (If you have not recorded once since turning on the camera, a standard brightness is used.)
[1*] (Mode 1)	The brightness is increased.
[2*] (Mode 2)	The brightness is standard.
[3*] (Mode 3)	The brightness is decreased.

- Some subjects may look different from their actual appearance, but the recorded picture will not be affected.
- Setting [A\*] or [1\*] reduces the operating time.

### [m/ft]\*

Select how distance is displayed, in Ft or M.

\* Depending on the country or area where the camera was purchased, this is not displayed due to differences in specifications.



## [TV Connection]

### ■ [HDMI Mode (Play)]

Set the format for the output.

[AUTO]	Automatically sets the output resolution based on information from a connected TV.
[4K/30p]*	Outputs pictures with a output resolution of 3840×2160 pixels using a progressive scan method for the number of effective scanning lines (2,160 lines).
[4K/25p]*	Outputs pictures with a output resolution of 3840×2160 pixels using a progressive scan method for the number of effective scanning lines (2,160 lines). Even when [4K/25p] is set, MP4 motion pictures recorded with [4K/100M/30p] will be output at a resolution of "4K/30p".
[1080p]	Outputs pictures using a progressive scan method for the number of effective scanning lines (1,080 lines).
[1080i]	Outputs pictures using an interlace scan method for the number of effective scanning lines (1,080 lines).
[720p]	Outputs pictures using a progressive scan method for the number of effective scanning lines (720 lines).
[480p]*	Outputs pictures using a progressive scan method for the number of effective scanning lines (480 lines).
[576p]*	Outputs pictures using a progressive scan method for the number of effective scanning lines (576 lines). Depending on the connected TV, 480 available scan lines may be used for output.

\* Depending on the country or area where the camera was purchased, this is not displayed due to differences in specifications.

- If no image appears on the TV with [AUTO], switch the setting to one other than [AUTO] to set a format supported by your TV. (Please read the operating instructions for the TV.)

### ■ [VIERA Link]

If you select [ON], operations of the camera and the VIERA Link compatible equipment connected to the camera with an HDMI micro cable are automatically linked, enabling you to control the camera with the remote control of the VIERA Link compatible equipment.

(→251)



### [Language]

Set the language displayed on the screen.

- If you set a different language by mistake, select [00] from the menu icons to set the desired language.

### [Version Disp.]

Check the firmware version of the camera.

- When you press [MENU/SET] while the version is displayed, software information for this unit, such as the license, is displayed.

### [Folder / File Settings]

Set the names of a folder and file for storing images.

Folder name	File name
<ul style="list-style-type: none"> <li>① Folder number (3-digits, 100–999)</li> <li>② User-defined 5-digit number</li> </ul>	<ul style="list-style-type: none"> <li>① Color space (sRGB)</li> <li>② User-defined 3-digit number</li> <li>③ File number (4-digits, 0001–9999)</li> <li>④ File extension</li> </ul>



<b>[Select Folder]</b>	Selects a folder for storing images. <ul style="list-style-type: none"> <li>The number of files that can be stored is displayed for the folder name.</li> </ul>	
<b>[Create a New Folder]</b>	Creates a new folder by advancing the folder number. <ul style="list-style-type: none"> <li>When no folder for storing images is available on a card, the folder number reset screen is displayed.</li> </ul>	
	<b>[OK]</b>	Creates a new folder using the same user-defined 5-digit number comprising a folder name as the current setting.
	<b>[Change]</b>	Creates a new folder by entering a new user-defined 5-digit number comprising a folder name to change the current folder name. <ul style="list-style-type: none"> <li>Characters that can be set: uppercase alphanumeric characters, numbers, and [ _ ]</li> <li>For details on how to enter characters, refer to “Entering Text” (<a href="#">→52</a>)</li> </ul>
<b>[File Name Setting]</b>	<b>[Folder Number Link]</b>	Sets the same number in the folder name to a user-defined 3-digit number in a file name.
	<b>[User Setting]</b>	Sets a file name by entering a new user-defined 3-digit number. <ul style="list-style-type: none"> <li>Characters that can be set: uppercase alphanumeric characters, numbers, and [ _ ]</li> <li>For details on how to enter characters, refer to “Entering Text” (<a href="#">→52</a>)</li> </ul>

- Up to 1,000 files can be stored in a single folder.
- The serial numbers from 0001 to 9999 are assigned to the files stored in the order in which pictures are taken. When a folder destination is changed, the file is stored with the file number following the preceding file number.
- In the following cases, a new folder is automatically created by advancing the folder number when the next file is saved.
  - When 1,000 files are stored in a folder
  - When a file consisting of the file number of “9999” is stored in a folder
- When folders with numbers from 100 to 999 already all exist, you cannot create a new folder. We recommend saving all necessary pictures to your computer or other devices and formatting the card.



### [No.Reset]

Reset picture file numbers. (The folder number is updated and the file number starts from 0001.)

- To reset folder number to 100:  
First, format the card, and reset the file numbers using [No.Reset]. Then, select [Yes] on the folder number reset screen.
- A folder number between 100 and 999 can be assigned.  
Numbers cannot be reset once folder number reaches 999. In this case, save all necessary pictures to your computer, and format the card (→28).

### [Reset]

The following settings are reset to the default:

- **Recording settings and drive mode**
- **Setup settings ([Wi-Fi Setup] and [Bluetooth] settings)**
- **Custom settings ([Face Recog.] and [Profile Setup] settings)**
- **Setup/custom settings  
(except for [Wi-Fi Setup], [Bluetooth], [Face Recog.] and [Profile Setup] settings)**
  - When the setup/custom settings are reset, the following settings are also reset:
    - The [World Time] setting
    - The [Travel Date] setting (Departure date, Return date, [Location])
    - The settings of [Rotate Disp.] and [Picture Sort] in the [Playback] menu
  - Folder numbers and clock settings will not be reset.

### [Reset Network Settings]

Settings such as equipment information you have registered using [Wi-Fi Setup] or [Bluetooth] are restored to the settings at the time of purchase.



### [Level Gauge Adjust.]

#### ■ [Adjust.]

Hold the camera in a horizontal position, and press [MENU/SET]. The level gauge will be adjusted.

#### ■ [Level Gauge Value Reset]

Restores the default level gauge setting.

### [Demo Mode]

You can try focusing, peaking, etc. in [Post Focus], with the image picture.

### [Approved Regulations]\*

The authentication number is displayed.

\* Depending on the country or area where the camera was purchased, this is not displayed due to differences in specifications.

## [My Menu]

### [My Menu Setting]

You can register frequently used menus and display them on [My Menu]. Up to 23 menus can be registered.

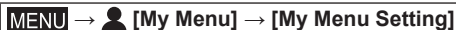

[Add]	Select and register a menu to be displayed on [My Menu].
[Sorting]	Change the order of the menus to be displayed on [My Menu]. Select the menu whose order you want to change and set the new location.
[Delete]	Delete a registered menu from the [My Menu] display. <b>[Delete Item]:</b> Select and delete a menu. <b>[Delete All]:</b> Delete all registered menus.
[Display from My Menu]	Set the initial display for the menu screen. <b>[ON]:</b> Displays [My Menu] <b>[OFF]:</b> Displays the menu used the previous time

## [Playback]

- [Slide Show] (→207)
- [Playback Mode] (→208)
- [Protect] (→209)
- [Rating] (→209)
- [Title Edit] (→210)
- [Face Rec Edit] (→210)
- [RAW Processing] (→211)
- [4K PHOTO Bulk Saving] (→213)
- [Light Composition] (→214)
- [Sequence Composition] (→215)
- [Clear Retouch] (→216)
- [Text Stamp] (→217)
- [Resize] (→218)
- [Cropping] (→219)
- [Rotate] (→219)
- [Video Divide] (→220)
- [Time Lapse Video] (→220)
- [Stop Motion Video] (→221)
- [Rotate Disp.] (→221)
- [Picture Sort] (→221)

● It may not be possible to set or edit pictures taken with other cameras.

### ■ How to select an image(s) after selecting [Single] or [Multi]

When [Single] and [Multi] are not available, select a picture in the same way as when [Single] is selected.

#### [Single]

- ① Use ◀▶ to select a still picture and press [MENU/SET]
  - If [Set/Cancel] is displayed at the right bottom of the screen, the setting is canceled when [MENU/SET] is pressed again.

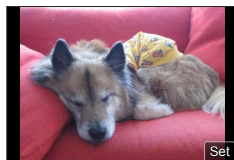

#### [Multi]

When a screen similar to the one on the right is displayed:

- ① Use ▲▼◀▶ to select a still picture and press [MENU/SET] (repeat)
  - To cancel → Press [MENU/SET] again.
- ② Press [DISP.] button to execute

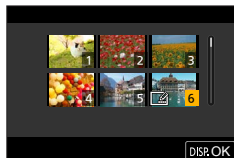

When a screen similar to the one on the right is displayed:

- ① Use ▲▼◀▶ to select a still picture and press [MENU/SET] (repeat)
  - To cancel → Press [MENU/SET] again.

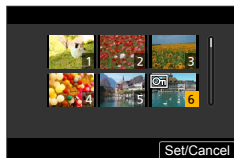

**[Slide Show]**





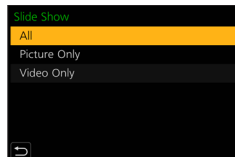

Automatically plays back recorded pictures, one after another. You can organize slide shows composed of only still pictures or only motion pictures. Recommended when viewing on TV screen.

**MENU** →  **[Playback]** → **[Slide Show]**

**1 Use ▲ ▼ to select the item and press [MENU/SET]**

- If you select [Picture Only], 4K burst files and pictures recorded using [Post Focus] will also be played back.
- Only an in-focus representative image will be played back from pictures recorded using [Post Focus].

**2 Use ▲ to select [Start] and press [MENU/SET]****■ Operations during Slide Show**

Operation	Touch operation	Description
▲		Play / Pause
◀		Previous
▶		Next
▼		Stop
		Volume down / Volume up

### ■ To change settings

Select [Effect] or [Setup] and press [MENU/SET].

[Effect]		This allows you to select the screen effects when switching from one picture to the next.
[Setup]	[Duration]	[Duration] can be set only when [Effect] is set to [OFF].
	[Repeat]	[ON] / [OFF]
	[Sound]	[AUTO]: With still pictures, music will play back, and with motion pictures, audio will play back. [Music]: Music effect will play back. [Audio]: Audio is played back from motion pictures. [OFF]: Music and audio will not play back.

- During slide shows of 4K burst files, pictures recorded in [Post Focus], or group pictures, effects will stay turned off even if [Effect] is set.
- When you play back the following pictures in a slide show, the [Duration] setting is disabled.
  - Motion pictures
  - 4K burst files
  - Pictures recorded using [Post Focus]
  - Group pictures

### [Playback Mode]

Selects the type of the pictures and play back. ([Normal Play], [Picture Only], [Video Only])

**MENU** →  **[Playback]** → **[Playback Mode]**

### 1 Use ▲ ▼ to select the item and press [MENU/SET]

- If you select [Picture Only], 4K burst files and pictures recorded using [Post Focus] will also be played back.

**[Protect]**

Set protection to disable picture deletion. Prevents deletion of important pictures.

**MENU** →  **[Playback]** → **[Protect]**

**1 Select picture (→206)****■ To clear all**

Select **[Protect]** → **[Cancel]** → **[Yes]**, and then press **[MENU/SET]**



When you set the write-protect switch on the card to the "LOCK" position, the picture is not erased.

- The picture is erased when formatting, even if it is protected.
- May not be effective when using other devices.

**[Rating]**

You can label the pictures in five levels (ratings). When you have performed **[Rating]**, the following operations will be available.

- Deletes all pictures except the labelled pictures.
- Use the file details view on a PC, etc., to check the rating level. (JPEG images only)

**MENU** →  **[Playback]** → **[Rating]**

**1 Select picture (→206)****2 Use ◀▶ to set the Rating levels (1 to 5) and press [MENU/SET]**

(Repeat steps **1** and **2** to perform the setting with **[Multi]**.)

**■ To clear all**

Select **[Rating]** → **[Cancel]** → **[Yes]**, and then press **[MENU/SET]**

- When you have performed **[Rating]** for group pictures, the setting applies to all pictures in the group, and the number rating set is shown on the rating settings icon of the first picture. If the total number of pictures is 1,000 or higher, [999+] is displayed.
- Only when **[Playback Mode]** is set to **[Normal Play]**, you can select **[Cancel]**.

**[Title Edit]**

You can enter characters (titles etc.) on a recorded picture. After text has been registered, it can be stamped in prints using [Text Stamp] (→217).

**MENU** →  **[Playback]** → **[Title Edit]**

**1 Select a still picture (→206)**

-  is displayed for pictures with texts already stamped.

**2 Enter characters**

- For details on how to enter characters, refer to “Entering Text” (→52)
- To delete texts, delete all the characters in the character input screen.

- You can print out texts using the “PHOTOfunSTUDIO” software.
- You can set up to 100 pictures at one time with [Multi].
- This function is not available in the following cases:
  - Motion pictures
  - 4K burst files
  - Pictures recorded using [Post Focus]
  - Still pictures recorded with the [Quality] setting [RAW:⚙️], [RAW:⚙️] or [RAW]

**[Face Rec Edit]**

Edit or delete the recognition information for pictures with incorrect information.

**MENU** →  **[Playback]** → **[Face Rec Edit]** → **[REPLACE]** or **[DELETE]**

**1 Use ◀▶ to select picture and press [MENU/SET]****2 Use ◀▶ to select a person and press [MENU/SET]**

- If [DELETE], go to step 4.

**3 Use ▲▼◀▶ to select the person to replace for another and press [MENU/SET]****4 Use ◀ to select [Yes] and press [MENU/SET]**

- When Face Recognition information is deleted, it cannot be restored.
- Edit the Face Recognition information in group units for a picture group. (You cannot edit the information for each picture in a group.)
- You can edit only the first picture in a group.

## [RAW Processing]

You can use the camera to develop still pictures that were recorded in RAW format. The created still pictures are saved in JPEG format.

**MENU** →  **[Playback]** → **[RAW Processing]**

**1** Press **◀▶** to select RAW file and press **[MENU/SET]**

**2** Press **▲▼** to select the item and then press **[MENU/SET]** to set

- The following items can be set. The settings used during recording are applied at the time of setting.

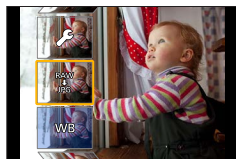



<b>[White Balance]</b>	You can select White Balance to make adjustments. When you select an item with  , you can develop the pictures using the same settings that were applied for recording.
<b>[Brightness correction]</b>	You can correct brightness in the range from -2 EV to +2 EV.
<b>[Photo Style]</b>	You can select the [Photo Style] effects.
<b>[i.Dynamic]</b>	You can select the [i.Dynamic] settings.
<b>[Contrast]</b>	You can adjust the contrast.
<b>[Saturation] / [Color Tone]</b>	You can adjust the saturation. (You can adjust the coloring when [Monochrome] is selected for [Photo Style].)
<b>[Filter Effect]</b>	You can select a Filter effect. (Only when [Monochrome] is selected for [Photo Style].)
<b>[Noise Reduction]</b>	You can set noise reduction.
<b>[i.Resolution]</b>	You can select the [i.Resolution] settings.
<b>[Sharpness]</b>	You can adjust the impression of resolution.
<b>[More Settings]</b>	Use <b>▲▼</b> to select items and press <b>[MENU/SET]</b> to perform the following operations. <b>[Reinstate Adjustments]:</b> You can restore the settings to the ones used during recording. <b>[Picture Size]:</b> You can select the picture size ([L], [M], or [S]) of a JPEG file when saving pictures.

**3 Press [MENU/SET] to finalize the setting**

- The screen in step 2 reappears. To set another item, repeat steps 2 to 3.

**4 Press ▲ ▼ to select [Begin Processing] and press [MENU/SET]****■ Setting each item**

When you select an item, the setting screen appears.



Operation	Touch operation	Description
	Drag	Used to make adjustments
		
▲	[WB K Set]	Used to display the color temperature setting screen (Only when [White Balance] is set to [K])
▼	[Adjust.]	Used to display the White Balance fine adjustment screen (Only when [White Balance] is set)
[DISP.]	[DISP.]	Used to display the comparison screen
[MENU/SET]	[Set]	Used to finalize an adjustment you just made and to return to the item selection screen





- If you have selected [Noise Reduction], [i.Resolution], or [Sharpness], the comparison screen is not displayed.
- Pictures can be enlarged by operating the zoom lever.
- You can also zoom in by quickly touching the display twice. (If the display was enlarged, it returns to the same magnification ratio.)

The following operating methods are available to make adjustments on the comparison screen.

Ⓐ Current setting

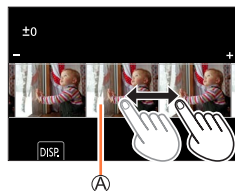
Operation	Touch operation	Description
	<b>Drag</b>	Used to make adjustments
		
<b>[DISP.]</b>	<b>[DISP.]</b>	Used to return to the setting screen
<b>[MENU/SET]</b>	<b>[Set]</b>	Used to finalize an adjustment you just made and to return to the item selection screen



- If you touch the picture at the center, it will be enlarged. If you touch , the picture will be reduced to the original size.

- The result of a RAW file developed by this camera and a RAW file developed by the software "SILKYPIX Developer Studio" will not be exactly the same.
- A RAW image recorded on this camera is always recorded with the aspect ratio set to [4:3] (5184×3888), but if you perform [RAW Processing] from the [Playback] menu, the picture will be processed with the aspect ratio fixed as that at the time of recording.
- Edit group pictures one by one. The edited pictures will be newly saved separately from the original group pictures.
- When an HDMI micro cable is connected, [RAW Processing] is disabled.
- You can perform RAW processing on pictures recorded using this unit only.

### [4K PHOTO Bulk Saving]

You can bulk save 5 seconds' worth of 4K recording from a 4K burst file.

**MENU** →  **[Playback]** → **[4K PHOTO Bulk Saving]**

#### 1 Use to select the 4K burst files and press **[MENU/SET]**

- If the burst time is 5 seconds or less, all the frames can be saved as a picture.

#### 2 Select the first frame to be bulk saved as a picture (→118, 119)

- The picture will be saved in JPEG format as a single burst picture group.

## [Light Composition]

Select multiple frames from 4K burst files that you wish to combine. Parts of the image that are brighter than the preceding frame will be superimposed on the preceding frame to combine the frames into one picture.



**MENU** → [Playback] → [Light Composition]

**1** Use ◀▶ to select the 4K burst files and press [MENU/SET]

**2** Choose the combining method and press [MENU/SET]

### ■ [Composite Merging]: Selecting frames to combine

① Drag the slide bar or use ▲▼◀▶ to select the frames to combine

② Press [MENU/SET]

- The selected frames are remembered, and the display goes to the preview screen.
- Use ▲▼ to select items and press [MENU/SET] to perform the following operations.
  - [Next]: Lets you select more frames for combining.
  - [Reselect]: Discards the frame selected immediately before and lets you select a different image.

③ Repeat steps ① - ② to select more frames to combine (up to 40 frames)

④ Press ▼ to select [Save], and then press [MENU/SET]

### ■ [Range Merging]: Selecting a range to combine

① Select the frame of the first picture and then press [MENU/SET]

- The selection method is the same as in step ① of [Composite Merging] setting.

② Select the frame of the last picture and then press [MENU/SET]

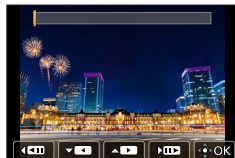

- Pictures are saved in JPEG format. Recording information (Exif information) of the first frame such as shutter speed, aperture, and ISO sensitivity are also registered.

**[Sequence Composition]**

Select multiple frames from a 4K burst file to create a sequence composition of a moving subject into one picture.



**MENU** → **[Playback]** → **[Sequence Composition]**

**1** Use to select the 4K burst files and press **[MENU/SET]**

**2** Select frames to combine

Select the frames so that the moving subject will not overlap on the preceding or subsequent frames. (The sequence composition may not be created properly if the subject overlaps.)

① Drag the slide bar or use to select the frames to combine

② Press **[MENU/SET]**

- The selected frames are remembered, and the display goes to the preview screen.
- Use to select items and press **[MENU/SET]** to perform the following operations.
  - **[Next]**: Lets you select more frames for combining.
  - **[Reselect]**: Discards the frame selected immediately before and lets you select a different image.

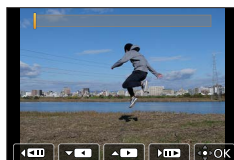

③ Repeat steps ① - ② to select more frames to combine (from 3 to 40 frames)

④ Press to select **[Save]**, and then press **[MENU/SET]**

**Tips for [Sequence Composition]**

We recommend using a tripod to take pictures for **[Sequence Composition]**.

- Pictures are saved in JPEG format. Recording information (Exif information) of the first frame such as shutter speed, aperture, and ISO sensitivity are also registered.

## [Clear Retouch]

You can erase unnecessary parts recorded on the pictures taken.

- The erasure operation can only be performed by touching. [Clear Retouch] automatically enables the touch operation.



**MENU** → **[Playback]** → **[Clear Retouch]**

### 1 Use ◀▶ to select a still picture and press [MENU/SET]

### 2 Drag your finger over the part you want to erase

- The parts to be erased are colored.
- Touching [Undo] will return the colored part back to its previous state.



### Erasing details (enlarging the display)

#### ① Touch [SCALING]

- On the touch screen, pinch out your two fingers to zoom in, and pinch in your two fingers to zoom out.
- Dragging the screen allows you to move the enlarged part.

#### ② Touch [REMOVE]

- This will bring you back to the operation of dragging your finger over the part you want to erase. The part you want to erase can be dragged even while the picture is enlarged.



### 3 Touch [Set]

### 4 Touch [Save] or press [MENU/SET]

- Pictures may appear unnatural because the background of deleted parts is artificially created.
- Edit group pictures one by one. The edited pictures will be newly saved separately from the original group pictures.
- When an HDMI micro cable is connected, [Clear Retouch] is disabled.
- This function is not available in the following cases:
  - Motion pictures
  - 4K burst files
  - Pictures recorded using [Post Focus]
  - Still pictures recorded with the [Quality] setting [RAW]

**[Text Stamp]**



You can stamp the recording date and time, names, travel destination, travel dates, etc. on the recorded still pictures.

**MENU** →  **[Playback]** → **[Text Stamp]**

**1 Select a still picture (→206)**

-  appears on screen if the picture is stamped with text.

**2 Use ▼ to select [Set] and press [MENU/SET]**

<b>[Shooting Date]</b>	[W/O TIME]: Stamp recording date [WITH TIME]: Stamp recording date and time
<b>[Name]</b>	 : Stamp name registered in Face Recognition  : Stamp name registered in [Profile Setup]
<b>[Location]</b>	Stamp location registered in [Setup] menu's [Travel Date]
<b>[Travel Date]</b>	Stamp number of days that have elapsed since the travel date set in [Setup] menu's [Travel Date]
<b>[Title]</b>	Stamp text registered in [Title Edit]

**3 Press [↵] button****4 Use ▲ to select [OK] and press [MENU/SET]**

- **Do not request date printing in store or make date printing on printer for still pictures with date stamps. (Date printing may be overlapped.)**
- You can set up to 100 pictures at one time with [Multi].
- The picture quality may be coarser.
- If you stamp text on the pictures in a group, the edited pictures will be newly saved separately from the original group pictures.
- This function is not available in the following cases:
  - Motion pictures
  - 4K burst files
  - Pictures recorded using [Post Focus]
  - Still pictures recorded with the [Quality] setting [RAW]
  - Still pictures that other texts had already been stamped
  - Still pictures taken without setting clock

**[Resize]**

Picture size can be reduced to facilitate e-mail attachment and use in web pages, etc.

**MENU** → **▶** **[Playback]** → **[Resize]**

**1 Select a still picture and size****[Single]**

- ① Use ◀▶ to select a still picture and press [MENU/SET]
- ② Use ▲▼ to select size and press [MENU/SET]

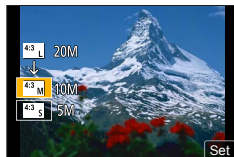
**[Multi] (up to 100 pictures)**

- ① Use ▲▼ to select size and press [MENU/SET]
- ② Use ▲▼◀▶ to select a still picture and press [MENU/SET] (repeat)
  - To cancel → Press [MENU/SET] again.
- ③ Press [DISP.] button to execute

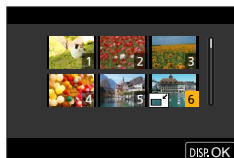

- Picture quality is reduced after resizing.
- This function is not available in the following cases:
  - Motion pictures
  - 4K burst files
  - Pictures recorded using [Post Focus]
  - Still pictures recorded with the [Quality] setting [RAW]
  - Group pictures
  - Still pictures that other texts had already been stamped





**[Cropping]**

Enlarge your still pictures and crop unwanted areas.

**MENU** →  **[Playback]** → **[Cropping]**

**1** Use   to select a still picture and press **[MENU/SET]**

**2** Select area to crop and press **[MENU/SET]**

Operation	Touch operation	Description
		Enlarges the picture
		Reduces the picture
	<b>Drag</b>	Moves the enlarged area

- Edit group pictures one by one. The edited pictures will be newly saved separately from the original group pictures.
- Original Face Recognition information will not be copied when still pictures are cropped.
- Picture quality is reduced after cropping.
- This function is not available in the following cases:
  - Motion pictures
  - 4K burst files
  - Pictures recorded using [Post Focus]
  - Still pictures recorded with the [Quality] setting [RAW]
  - Still pictures that other texts had already been stamped



**[Rotate]**

You can manually rotate the picture in 90-degree units.

- You cannot select [Rotate] when [Rotate Disp.] is set to [OFF].

**MENU** →  **[Playback]** → **[Rotate]**

**1** Use   to select picture and press **[MENU/SET]**

**2** Use   to select the rotation direction and press **[MENU/SET]**

: Rotate a picture 90 degrees clockwise.

: Rotate a picture 90 degrees counterclockwise.

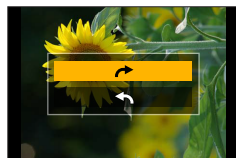



## [Video Divide]

A single motion picture can be split into 2 parts. This is convenient when you want to keep just the necessary scenes, or if you wish to delete unnecessary scenes to increase free space on your card, such as when traveling.

**MENU** →  **[Playback]** → **[Video Divide]**

**1** Use   to select a motion picture to split and press **[MENU/SET]**

**2** Press  at where you want to split a motion picture to pause it

- If you press   while paused, you can make finer adjustments to the splitting positions in a motion picture.

**3** Press 

- **The original motion picture that was split does not remain.**  
(There will only be the 2 motion pictures that were created after the split.)





- During dividing, do not turn off the camera or remove the card or battery. If you do so, the motion picture may be deleted.
- Motion pictures cannot be divided at a location close to the start or end of the motion picture.
- This function is not available in the following case:
  - Motion pictures with a short recording time

## [Time Lapse Video]

You can create a motion picture from the pictures in a group that was recorded using [Time Lapse Shot].

**MENU** →  **[Playback]** → **[Time Lapse Video]**

**1** Use   to select the [Time Lapse Shot] picture group and press **[MENU/SET]**

**2** Create a motion picture after selecting a production method

- For details, refer to step **4** and the subsequent steps (→132).

**[Stop Motion Video]**

You can create a motion picture from the pictures in a group that was recorded using [Stop Motion Animation].

**MENU** →  **[Playback]** → **[Stop Motion Video]**

**1** Use ◀▶ to select a stop motion animation group and press **[MENU/SET]**

**2** Create a motion picture after selecting a production method

- For details, refer to step **7** and the subsequent steps (→135).

**[Rotate Disp.]**

This mode allows you to display pictures vertically if they were recorded holding the camera vertically.

**MENU** →  **[Playback]** → **[Rotate Disp.]** → **[ON]**

- When you play back pictures on a PC, they cannot be displayed in the rotated direction unless the OS or software is compatible with Exif. Exif is a file format for still pictures which allows recording information, etc. to be added. It was established by "JEITA (Japan Electronics and Information Technology Industries Association)".

**[Picture Sort]**

You can set the display sequence used for playing back pictures on this unit.

**MENU** →  **[Playback]** → **[Picture Sort]**

<b>[FILE NAME]</b>	Displays pictures in the folder name or file name sequence. This display format allows you to find the storage location of a picture on a card more easily.
<b>[DATE/TIME]</b>	Displays pictures according to the date and time that the pictures were taken in chronological order. When the pictures are taken using several cameras and stored on the same card, this display format allows you to find a specific picture more easily.

- Pictures may not be displayed according to the **[DATE/TIME]** sequence immediately after a card is inserted into this unit. In that case, wait a while, and the pictures will be displayed in the **[DATE/TIME]** sequence.

## What you can do with the Wi-Fi®/Bluetooth® function

### Operating the camera by connecting it to a smartphone

- Operating the shutter button of the camera using a smartphone (remote recording) (→233)
- Playing back or saving images stored on the camera (→236)
- Combining motion pictures recorded with Snap Movie according to your preference on a smartphone (→240)

### Expanding the scope of applications by connecting the camera to a smartphone compatible with Bluetooth Low Energy

- Pairing (connection setup) (→227)
  - Turning on/off the camera using a smartphone (→232)
  - Transferring recorded images to a smartphone automatically (→237)
  - Writing location information of a smartphone on a recorded image (→239)
  - Synchronizing the camera's clock with a smartphone (→240)
- This manual uses the term "smartphone" for both smartphones and tablets unless it is necessary to distinguish between them.

## Wi-Fi/Bluetooth Function

### ■ Before Use

- **Complete the date and time settings in advance.** (→31)
- To use the Wi-Fi function on this unit, a destination device equipped with the wireless LAN function is required.

### ■ Lighting of the WIRELESS connection lamp (Blue)

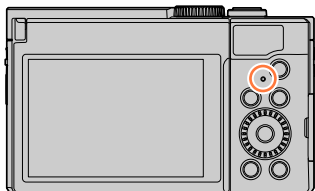

Lit: When the Wi-Fi/Bluetooth function is ON or connected

Blinking: When sending picture data

- In [Wireless Connection Lamp] in the [Setup] menu, you can set the lamp so that it will not light/flash. (→197)

### ■ [Wi-Fi] button

In this Operating Instructions, a function button to which [Wi-Fi] is assigned is referred to as the [Wi-Fi] button. (At the time of purchase, [Wi-Fi] is assigned to [Fn4] button in recording mode, and [Fn1] in playback mode.)

- For details on the function button, refer to (→48).

### To start up the Wi-Fi function (When in recording mode):

① Touch [Fn]



② Touch [Fn4]



■ **Operations that can be performed by pressing the [Wi-Fi] button**

If you press the [Wi-Fi] button when you do not have a Wi-Fi connection, the camera enters a standby mode in which it can connect directly to the smartphone. (→230)

When the camera is connected to Wi-Fi, you can press [Wi-Fi] button and perform the following operations.

[Terminate the Connection]	Terminates the Wi-Fi connection.
[Change the Destination]	Terminates the Wi-Fi connection, and allows you to select a different Wi-Fi connection.
[Change Settings for Sending Images]	For details (→244).
[Register the Current Destination to Favorite]	Registering the current connection destination or the connection method, you can easily connect with the same connection method next time.
[Network Address]	For details (→248).

- Depending on the Wi-Fi function being used or the connection destination, you may not be able to perform some of these operations.

## Wi-Fi/Bluetooth Function

**■ Describing method**

When selecting “[Select a destination from History]”, etc. is described in a step, perform any of the following operations.

**With cursor button operations**

Use cursor button to select [Select a destination from History] and press [MENU/SET].

**With touch screen operations**

Touch [Select a destination from History].

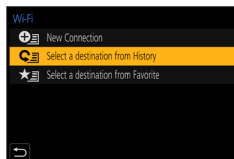

- **Do not remove the memory card or battery or move to an area without any reception while sending images.**
- We recommend that you use a fully charged battery when you send pictures.
- Pictures may not be completely sent depending on radio wave conditions. If the connection is terminated while sending pictures, pictures with missing sections may be sent.

## Connecting the camera to a smartphone

You can remotely operate the camera using a smartphone.

The “Panasonic Image App” (hereafter “Image App”) must be installed on your smartphone.

### Installing the smartphone/tablet app “Panasonic Image App”

<b>Supported OS</b>	<b>Android™: Android 10 or later</b> <b>iOS: iOS 15 or later</b>
<b>Installation procedure</b>	<ol style="list-style-type: none"> <li>① Connect your device to a network</li> <li>② (Android) Select “Google Play™ Store” (iOS) Select “App Store”</li> <li>③ Enter “Panasonic Image App” or “LUMIX” into the search box</li> <li>④ Select “Panasonic Image App” and install it</li> </ol>



- Use the latest version.
- Supported OS versions as of December 2024. Supported OS versions may be changed without prior notice.
- The service may not be able to be used properly depending on the type of smartphone being used.  
For the latest information on the “Image App”, refer to the support site below.  
<https://panasonic.jp/support/global/cs/dsc/> (This site is available in English only.)
- For details about the operating procedure, etc., refer to [Help] in the “Image App” menu.
- Some of the screens and information provided in this document may be different depending on the supported operating system and “Image App” version.

## Connecting the camera to a smartphone

## Connecting the camera to a smartphone compatible with Bluetooth Low Energy

You can connect the camera to a smartphone via a Bluetooth connection.

Supported smartphones

**Android: Android 10 or higher equipped with Bluetooth 4.0 or higher**  
(excluding those that do not support Bluetooth Low Energy)  
**iOS: iOS 15 or higher**

### ■ First-time connection

You need to set up pairing (connection) for the first time only. When pairing is set up, a Wi-Fi connection is made automatically.

#### (On the camera)

**MENU** →  **[Setup]** → **[Bluetooth]** → **[Bluetooth]**  
→ **[SET]** → **[Pairing]**

- The camera enters pairing standby mode and displays its device name.

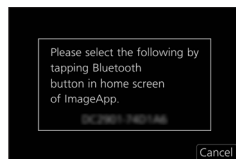

#### (On your smartphone)

- ① Start "Image App"
  - If a message is displayed indicating that the smartphone is searching for cameras, close the message.
- ② Select [Bluetooth]
- ③ Turn on the Bluetooth
- ④ Select the device name displayed on the camera's screen from the [Camera enable to be registered] list
  - Bluetooth connection between the camera and the smartphone will be made.  
(For Android devices) A Wi-Fi connection will be made by selecting [Connection].

**If you are using an Android device, follow the steps up to here to complete the setup. Proceed to the steps below only if you are using an iOS device.**

- You need to install the profile.
  - ① Install the profile
    - If the smartphone is locked with a passcode, enter the passcode to unlock the smartphone.
  - ② Exit the browser

## Connecting the camera to a smartphone

- ⑤ Turn on the Wi-Fi function in the setting menu
- ⑥ On the Wi-Fi setting screen, select the SSID displayed on the camera (The device name selected in step ④)
  - If the SSID is not displayed, it may be displayed after the Wi-Fi function is turned off and on.
  - When you need to change the connected device, follow the on-screen message to change the setting.
- ⑦ Start "Image App"
  - The paired smartphone will be registered as a paired device after connected via Wi-Fi.

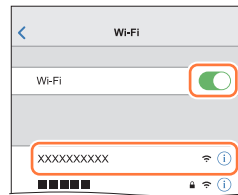

### ■ Connecting to the paired smartphone (connecting for the second and subsequent times)

#### (On the camera)

- ① Enable the Bluetooth function

**MENU** → [Setup] → [Bluetooth] → [Bluetooth] → [ON]

#### (On your smartphone)

- ② Start "Image App"
  - If a message is displayed indicating that the smartphone is searching for cameras, close the message.
- ③ Select [Bluetooth]
- ④ Turn on the Bluetooth
- ⑤ Select the device name displayed on the camera's screen from the [Camera registered] list
  - Even if you set up pairing with more than one smartphone, you can only connect to one smartphone at a time.

### ■ Terminating the Bluetooth connection

**MENU** → [Setup] → [Bluetooth] → [Bluetooth] → [OFF]

- The connection will be terminated and the camera's Bluetooth function will be deactivated.
- Even if you terminate the connection, the pairing information for it will not be deleted.

## Connecting the camera to a smartphone

**■ Deleting the pairing information****(On the camera)**

① Set the menu

**MENU** →  **[Setup]** → **[Bluetooth]** → **[Bluetooth]** → **[SET]** → **[Delete]**

② Select the smartphone you want to delete

**(On your smartphone)**

Select the camera (device name) for which to delete the pairing information from the [Camera registered] list, and delete the registration.

- **[🔗]** is displayed on the recording screen when a Bluetooth device is connected. If the Bluetooth function is enabled, but the smartphone is not connected, the displayed **[🔗]** is semi-transparent.
- When it takes time to set up pairing between a smartphone and a camera, delete the pairing information of both devices and register them again. This may enable the devices to be recognized properly.
- Up to 16 smartphones can be registered. If you try to register more than 16 devices, the smartphone with the oldest registration history will be replaced.
- Performing [Reset Network Settings] will delete registered device information.

## Connecting the camera to a smartphone

## Connecting the camera to a smartphone that does not support Bluetooth Low Energy

Connect to a smartphone via Wi-Fi.

- You can also connect via Wi-Fi to a smartphone that supports Bluetooth Low Energy by following the same steps.

### (On the camera)

**MENU** → **[Setup]** → **[Wi-Fi]** → **[Wi-Fi Function]** → **[New Connection]**  
→ **[Remote Shooting & View]**

- Ⓐ SSID and Password
- Ⓑ QR Code

- The information (QR Code, SSID and Password) required for directly connecting your smartphone to this unit is displayed.
- You can also display the information by pressing [Wi-Fi] button on the camera.



### (On your smartphone)

#### ■ When reading a QR Code to connect

- ① Start "Image App"
- ② Select "QR code"
  - When the smartphone is connected to a wireless access point, it may take time to display QR code.
  - (For iOS devices) A confirmation screen will be displayed. Select [OK] to proceed.
- ③ Use the "Image App" to scan the QR code displayed on the screen of the camera
  - If you press [MENU/SET] on the camera, the QR code will be enlarged.

**If you are using an Android device, follow the steps up to here to complete the setup. Proceed to the steps below only if you are using an iOS device.**

- ④ Install the profile
  - If the smartphone is locked with a passcode, enter the passcode to unlock the smartphone.
- ⑤ Exit the browser
- ⑥ Turn on the Wi-Fi function in the setting menu
- ⑦ On the Wi-Fi setting screen, select the SSID displayed on the camera
- ⑧ Start "Image App"
  - (iOS devices) Steps ① through ⑤ are not required from the second time on.



## Connecting the camera to a smartphone

### Manually entering a password to set up a connection

- ① Turn on the Wi-Fi function in the setting menu
- ② On the Wi-Fi setting screen, select the SSID displayed on the camera
- ③ Enter the password displayed on the camera (For first time connection only)
- ④ Start "Image App"

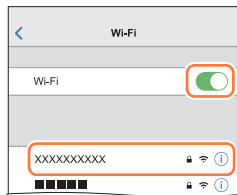

### Closing the Wi-Fi connection

#### 1 Set the camera to Recording Mode

- Press the shutter button halfway to return to recording mode.

#### 2 Select the camera's menu items to terminate the Wi-Fi connection

**MENU** →  **[Setup]** → **[Wi-Fi]** → **[Wi-Fi Function]**  
→ **[Yes]**

- You can also terminate the connection by pressing [Wi-Fi] button on the camera.

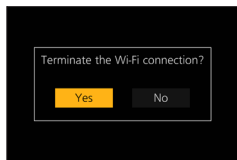

#### 3 On the smartphone, close "Image App"

- When recording with 4K Pre-Burst with the smartphone, terminate the connection only after switching to 4K Burst recording by pressing  button on the camera.

## Controlling with a Smartphone

### Required wireless connectivity mode

The wireless connectivity mode required varies depending on the function to be used after connecting to a smartphone.

Wireless connectivity required	Support for Bluetooth Low Energy
<b>Bluetooth</b>	Indicates that the function can be used with smartphones that support Bluetooth Low Energy.
Wi-Fi	Indicates that the function can be used with smartphones that do not support Bluetooth Low Energy.
<b>Bluetooth</b> Wi-Fi	Indicates that the function can be used with smartphones that support Bluetooth Low Energy. • Indicates that the function requires you to connect to a smartphone using both Bluetooth and Wi-Fi.

## Turning on/off the camera using a smartphone

Wireless connectivity required: **Bluetooth** Wi-Fi

Even when the camera is turned off, you can remotely turn on and operate it from your smartphone. This function allows you to turn on the camera from a distant location and take pictures or view images on the camera even when it is in your bag.



### 1 Make a Bluetooth connection to the smartphone (→227)

### 2 Select the camera's menu

**MENU** → [Setup] → [Bluetooth] → [Remote Wakeup] → [ON]

### 3 Turn off the camera

### 4 On the smartphone, start up the "Image App", and set the Bluetooth function to a state in which a connection can be made (standby state)

### 5 Operate the smartphone

① Select []





② Select [Remote operation]

- The camera automatically turns on, allowing it to make a Wi-Fi connection automatically.
- (iOS devices) Depending on the connection status of the smartphone, you may need to change the connected device on the Wi-Fi setup screen. Follow the on-screen message on the smartphone to change the setting.

## Controlling with a Smartphone

## ■ Turning off the camera with the smartphone

- ① Select []
- ② Select [ OFF]

- When [Remote Wakeup] is set to [ON], the Bluetooth function continues to operate even after the camera is turned off, thus causing the battery to drain.

## ■ Operating the shutter button of the camera using a smartphone (remote recording)

Wireless connectivity required: Wi-Fi

### 1 Connect to a smartphone (→230)

### 2 Operate the smartphone

If the camera is already connected to the smartphone via Bluetooth, select [] → [Remote operation].

(iOS devices) Depending on the connection status of the smartphone, you may need to change the connected device on the Wi-Fi setup screen. Follow the on-screen message on the smartphone to change the setting.



- ① Select []



- ② Take pictures
  - The recorded images are saved in the camera.
  - Some settings are not available.

## ■ Setting the higher priority between the camera and smartphone to perform operations

**MENU** →  [Setup] → [Wi-Fi] → [Wi-Fi Setup] → [Priority of Remote Device]

 [Camera]	<p>Allows you to perform operations with both the camera and the smartphone.</p> <ul style="list-style-type: none"> <li>• The camera's dial settings, etc. cannot be changed with the smartphone.</li> </ul>
 [Smartphone]	<p>Allows you to perform operations only with the smartphone during remote recording.</p> <ul style="list-style-type: none"> <li>• The camera's dial can also be operated with the smartphone.</li> <li>• To end remote recording, press any of the buttons on the camera to turn on the screen, and select [Cancel].</li> </ul>

- The setting of this function cannot be changed while the connection is active.

## Controlling with a Smartphone

---

- The camera could tilt when the lens barrel extends. Make sure to secure the camera in place with a tripod or by other means.
- This function is not available in the following case:
  - When using [Time Lapse Shot]

## Using the smartphone to operate the shutter button via a Bluetooth connection only

Wireless connectivity required: **Bluetooth**

### 1 Make a Bluetooth connection to the smartphone (→227)

### 2 Operate the smartphone

- ① Select [
- ② Select [Shutter Remote Control]
- ③ Take pictures



- You cannot use [Shutter Remote Control] to turn on the camera.
- The Live View screen of the camera cannot be viewed on a smartphone.
- This camera does not support the function for performing [B] (Bulb) recording by operating the recording button in "Image App."
- Read the [Help] in the "Image App" menu for further details on how to operate [Shutter Remote Control] of "Image App".

## Playing back or saving images stored on the camera

Wireless connectivity required: Wi-Fi

### 1 Connect to a smartphone (→230)

### 2 Operate the smartphone

If the camera is already connected to the smartphone via Bluetooth, select [🏠] → [Remote operation].

(iOS devices) Depending on the connection status of the smartphone, you may need to change the connected device on the Wi-Fi setup screen. Follow the on-screen message on the smartphone to change the setting.

#### ① Select [▶]

- You can switch a device of pictures to be displayed using the icon at the top left on the screen. Select [LUMIX] to display a picture saved in the camera.

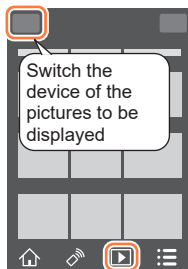

#### (Playing back a picture)

#### ② When the picture is touched, it is played back at a larger size

- When playing back motion pictures, the data size is reduced during transmission of motion pictures to "Image App". Therefore, the picture quality may be different from the actual motion picture that you have recorded. Depending on your smartphone and its usage environment, you may notice degradation in the picture quality or skipping of sound when playing back motion pictures and still pictures.

#### (Saving pictures)

#### ③ Press and hold the picture and drag it

- 4K motion pictures, 4K burst files, and pictures recorded with [Post Focus] cannot be saved.

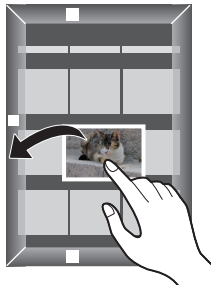

## Transferring recorded images to a smartphone automatically

Wireless connectivity required: **Bluetooth** **Wi-Fi**

The camera automatically transfers recorded images to a Bluetooth-connected smartphone via Wi-Fi.

### 1 Make a Bluetooth connection to the smartphone (→227)

### 2 Select the camera's menu

**MENU** →  **[Setup]** → **[Bluetooth]** → **[Auto Transfer]** → **[ON]**

- If a confirmation screen is displayed on the camera asking you to terminate the Wi-Fi connection, select [Yes] to terminate it.

### 3 On the smartphone, select [YES] (Android devices) or [Wi-Fi Setup] (iOS devices)

- The camera automatically makes a Wi-Fi connection.
  - (iOS devices) Follow the on-screen message on the smartphone to change the connected device on the Wi-Fi setup screen.

### 4 Check the send settings on the camera, and select [Set]

- To change the send setting, press [DISP.] button. (→244)
- The camera will enter a mode where it can automatically transfer images and  will be displayed on the recording screen. (If [Auto Transfer] is not displayed on the recording screen, images cannot be transferred automatically. Check the status of the Wi-Fi connections to the smartphone.)

### 5 Take pictures on the camera

- Every time you take a picture, it is automatically sent to a specified device.
- While sending a file,  is displayed on the recording screen.



If you set [Auto Transfer] to [ON] in advance, the Wi-Fi/Bluetooth connection will be automatically established and Auto Transfer enabled the next time you turn on the camera and start up "Image App" on your smartphone.

### ■ To stop the automatic transfer of images

In step **2**, select [OFF].

- A confirmation screen is displayed, asking you to terminate the Wi-Fi connection.

- **When [Auto Transfer] in the [Bluetooth] is set to [ON], [Wi-Fi Function] is disabled.**

- If the file transfer is interrupted because the camera turns off, turn the camera on again to restart file transfer.
  - You may not be able to resend the files that did not get delivered if there is a change in their storage status. For example, if you replace the card before turning on the camera again, the files may not be resent.
  - If the number of files that did not get delivered is large, it may not be possible to resend all of the files.
- Motion pictures, 4K burst files, and pictures recorded with [Post Focus] cannot be automatically transferred.

## Writing location information of a smartphone on a recorded image

Wireless connectivity required: **Bluetooth**

The smartphone sends its location information to the camera via Bluetooth, and the camera performs recording while writing the acquired location information.

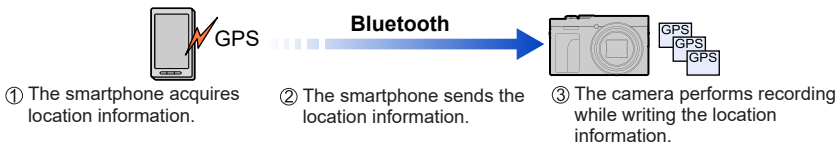

### Preparation

Enable the GPS function on the smartphone.

#### 1 Make a Bluetooth connection to the smartphone (→227)

#### 2 Select the camera's menu

**MENU** → **[Setup]** → **[Bluetooth]** → **[Location Logging]** → **[ON]**

- The camera will enter a mode where location information can be recorded and **[GPS]** will be displayed on the recording screen.

#### 3 Take pictures on the camera

- Location information will be written to the recorded pictures.

#### When the displayed **[GPS]** is semi-transparent

Location information is not acquired, so data cannot be written. Positioning with the GPS on the smartphone may not be possible if the smartphone is in a location such as a building or a bag.

- Move the smartphone to a location where positioning performance can be optimized, such as that offers a wide view of the sky, to try positioning.
- Refer to the operating instructions of your smartphone.

- Images with location information are indicated with **[GPS]**.
- **Be sure to pay special attention to the privacy, the likeness rights, etc. of the subject when you use this function. Use at your own risk.**
- The smartphone battery drains faster while location information is being recorded.

## Synchronizing the camera's clock with a smartphone

Wireless connectivity required: **Bluetooth**

Synchronize the [Clock Set] setting in the [Setup] menu and [Home] or [Destination] setting in the [World Time] of the camera with those of a smartphone.

**1** Make a Bluetooth connection to the smartphone (→227)

**2** Select the camera's menu

**MENU** →  [Setup] → [Bluetooth] → [Auto Clock Set] → [ON]

## Combining motion pictures recorded with Snap Movie according to your preference on a smartphone

Wireless connectivity required: **Wi-Fi**

Using a smartphone, you can combine motion pictures recorded with the camera's [Snap Movie] function. Music can be added to motion pictures to be combined.

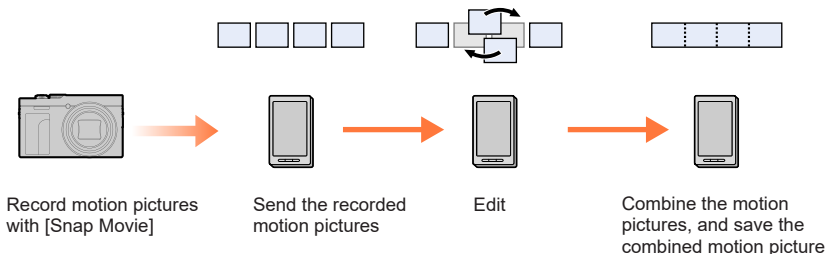

## ■ Combining motion pictures by operating a smartphone

① Connect to a smartphone (→230)

② Operate the smartphone

If the camera is already connected to the smartphone via Bluetooth, select [] → [Remote operation].

(iOS devices) Depending on the connection status of the smartphone, you may need to change the connected device on the Wi-Fi setup screen. Follow the on-screen message on the smartphone to change the setting.

① Select []



② Select []

- Transfer motion pictures recorded with [Snap Movie] to the smartphone according to the message displayed on the smartphone.

③ Operate the smartphone to edit the motion pictures

- Read the [Help] in the "Image App" menu for further details on how to operate [Snap Movie] of "Image App".

## Sending pictures to a smartphone

### Preparation

Install "Image App" in advance. (→226)

**MENU** →  **[Setup]** → **[Wi-Fi]** → **[Wi-Fi Function]** → **[New Connection]** → **[Send Images While Recording]** / **[Send Images Stored in the Camera]**

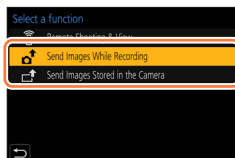

### 1 Connect to a smartphone

#### (On your smartphone)

- ① Set Wi-Fi function to "ON"
- ② Select the SSID displayed on this unit
- ③ Start "Image App"

### 2 Select the device you wish to connect to

### 3 Check the send settings, and select [Set]

- To change the send setting, press the [DISP.] button. (→244)

#### [Send Images While Recording]

### 4 Take a still picture (→243)

#### [Send Images Stored in the Camera]

### 4 Select the picture (→244)

- When [Auto Transfer] in the [Bluetooth] is set to [ON], [Wi-Fi Function] is disabled.

### Images that can be sent

JPEG	RAW	MP4	4K Burst File Pictures recorded in [Post Focus]
○	○	○*	—

\* Excluding 4K motion pictures. Sending by [Send Images While Recording] is not available.

- Some images may not be played back or sent depending on the device.
- For more information about picture playback, see the operating instructions of the destination device.

## Sending pictures to a smartphone

**[Send Images While Recording]**

A picture can be automatically sent to a specified device every time you take it.

- [Wi-Fi] is displayed on the recording screen while connected by [Send Images While Recording], and [Send] is displayed while files are being sent.
- To terminate the connection, follow the steps below:

**MENU** → [Wrench] [Setup] → [Wi-Fi] → [Wi-Fi Function] → [Yes]

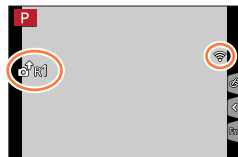

- You cannot change the settings while sending a still picture.
- Since the camera gives priority to recording, sending may take longer during the recording.
  - If you turn off the camera before you have completed sending, or if you close the Wi-Fi connection, or in similar situations, unsent files will not be resent.
  - You may not be able to delete files or use the [Playback] menu while sending.
  - If you set [Time Lapse Shot], the Wi-Fi connection is terminated and you cannot use this function.

## Sending pictures to a smartphone

**[Send Images Stored in the Camera]**

You can select and send recorded images.

**When selecting [Single Select]**

- ① Select the picture
- ② Select [Set]

**When selecting [Multi Select]**

- ① Select the picture (repeat)
  - If selected again, the setting will be canceled.
- ② Select [OK]

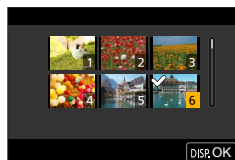

- To close the connection, select [Exit].

- Some images taken with a different camera may not be able to be sent.
- Images that have been modified or edited with a computer may not be able to be sent.

**Changing the settings for sending images**

After you have completed connecting, you can change the send settings, such as the size of pictures to be sent, by pressing the [DISP.] button.

[Size]	Resize the image to send. [Original] / [Change] ([M], [S], [VGA])
[File Format]	[JPG] / [RAW+JPG] / [RAW]

## Sending pictures to a smartphone

**■ Sending Images on the Camera to a Smartphone with Simple Operations**

You can transfer pictures to a smartphone connected by Bluetooth just by pressing [ ] ([Send Image (Smartphone)]) button during playback.

You can also use the menu to connect easily.

- Use the Fn button registered with [Send Image (Smartphone)] to operate. In default settings, this is registered in [Fn2]. For information about the Fn button, refer to page 48.

**Getting started:**

- Install "Image App" on your smartphone. (→226)
- Connect the camera to a smartphone by Bluetooth. (→227)
- Press [ ] on the camera to display the playback screen.

**Send a single image**

- 1 Press ◀▶ to select the image.
- 2 Press [ ].
- 3 Select [Single Select].
  - To change the send settings of images, press [DISP.]. (→244)
- 4 On the smartphone, select [Yes] (for Android devices) or [Join] (for iOS devices).
  - This connects automatically using Wi-Fi.

**Send multiple images**

- 1 Press [ ].
- 2 Select [Multi Select].
  - To change the send settings of images, press [DISP.]. (→244)
- 3 Select the images and then transfer.
  - ◀▶: Select images
  -  : Set/Cancel
  - [DISP.]: Transfer
- 4 On the smartphone, select [Yes] (for Android devices) or [Join] (for iOS devices).
  - This connects automatically using Wi-Fi.

**Using the menu to transfer easily**

**MENU** →  [Setup] → [Bluetooth] → [Send Image (Smartphone)]

Settings: [Single Select]/[Multi Select]

- If [Single Select], press ◀▶ to select the image and then press  to execute.
- If [Multi Select], use the same operation as with "Send multiple images".

- This function is not available when [Auto Transfer] in [Bluetooth] is set to [ON].

## About Wi-Fi connections

The following types of connections are available.

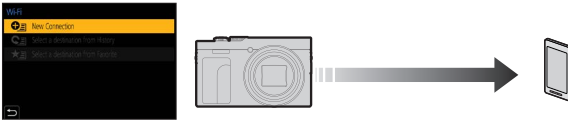
<b>MENU</b> →  <b>[Setup]</b> → <b>[Wi-Fi]</b> → <b>[Wi-Fi Function]</b>	
<b>[New Connection]</b>	Select the Wi-Fi function to connect. 
<b>[Select a destination from History] / [Select a destination from Favorite]</b>	Connection is made using the same settings as the previous time. (→246)

### Connecting quickly with the same settings as used previously ([Select a destination from History] / [Select a destination from Favorite])

The camera keeps a History of times you used the Wi-Fi function. You can register items in the History to Favorite.

You can easily connect with the same settings as used previously by connecting from History or Favorite.

- If the Wi-Fi settings of the device to connect to have been changed, it may not be possible to connect to the device.

#### 1 Set the menu

**MENU** →  **[Setup]** → **[Wi-Fi]** → **[Wi-Fi Function]**

<b>[Select a destination from History]</b>	Connects using the same settings as used previously.
<b>[Select a destination from Favorite]</b>	Connects using settings registered in Favorite.

#### 2 Select the desired connection setting

- When selecting History or Favorite items, you can view connection details by pressing the [DISP.] button.

## Registering History items to Favorite

**MENU** →  [Setup] → [Wi-Fi] → [Wi-Fi Function]  
→ [Select a destination from History]

**1** Select the item you wish to register and press ►

**2** Enter a registration name

- For details on how to enter characters, refer to “Entering Text” (→52)
- Up to 30 characters can be entered. A double-byte character will be treated as two characters.

## Editing items registered in Favorite

**MENU** →  [Setup] → [Wi-Fi] → [Wi-Fi Function]  
→ [Select a destination from Favorite]

**1** Select the Favorite item you wish to edit and press ►

[Remove from Favorite]	—
[Change the Order in Favorite]	Select the destination.
[Change the Registered Name]	• For details on how to enter characters, refer to “Entering Text” (→52)

- The number of settings that can be saved in the history is limited. Register and save frequently used Wi-Fi connection settings to Favorites.
- Performing [Reset Wi-Fi Settings] deletes content registered in History and Favorite.
- If the device you want to connect to (smartphone, etc.) is connected to a wireless access point other than the camera, you cannot connect the device to the camera. Change the Wi-Fi settings of the device you want to connect to so that the access point to be used is set to the camera. You can also select [New Connection] and reconnect the devices. (→246)

## [Wi-Fi Setup]

Configure the settings required for the Wi-Fi function.  
 [Wi-Fi Setup] cannot be changed when connected to Wi-Fi.

**MENU** →  **[Setup]** → **[Wi-Fi]** → **[Wi-Fi Setup]**

<b>[Priority of Remote Device]</b>	(→233)
<b>[Device Name]</b> You can change the name (SSID) of this unit.	<ol style="list-style-type: none"> <li>① Press [DISP.] button</li> <li>② Enter the desired device name (Up to 32 characters can be entered)           <ul style="list-style-type: none"> <li>• For details on how to enter characters, refer to “Entering Text” (→52)</li> </ul> </li> </ol>
<b>[Wi-Fi Function Lock]</b> To prevent incorrect operation or use of the Wi-Fi function by a third party and to protect saved personal information, it is recommended that you protect the Wi-Fi function with a password.	<p><b>[Setup]:</b> Enter any 4-digit numbers as the password.</p> <p><b>[Cancel]</b></p> <ul style="list-style-type: none"> <li>• For details on how to enter characters, refer to “Entering Text” (→52)</li> <li>• If you forget the password, you can reset it with [Reset Network Settings] (→204) in the [Setup] menu.</li> </ul>
<b>[Network Address]</b> Displays the MAC address and IP address of this unit.	<ul style="list-style-type: none"> <li>• A “MAC Address” is a unique address that is used to identify network equipment.</li> <li>• “IP address” refers to a number that identifies a PC connected to a network such as the Internet. (Example: 192.168.0.87)</li> </ul>

### Enjoying 4K motion pictures

#### Viewing 4K motion pictures

##### ■ Viewing on TV screen

When you connect this unit to a 4K-compatible TV and play back a motion picture recorded with [Rec Quality] of [4K], you can enjoy high-resolution 4K motion pictures. Although resolution output will be lower, you can also play back 4K motion pictures by connecting to a high-definition TV and other devices that do not have 4K support.

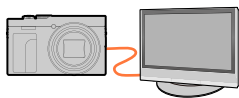

##### Preparations

- **With camera models DC-ZS99P/DC-ZS99PP/DC-TZ99GD:**  
Set [HDMI Mode (Play)] (→201) to [AUTO] or [4K/30p].
- **With camera models DC-TZ99E/DC-TZ99GA/DC-TZ99GH/DC-TZ99GN:**  
Set [HDMI Mode (Play)] (→201) to [AUTO] or [4K/25p].
- When connecting to a TV that does not support 4K motion picture, select [Auto].

- ① Connect this unit to a 4K-compatible TV using an HDMI micro cable and display the playback screen (→250)
  - When the [VIERA Link] setting on the camera is set to [ON] and the camera is connected to a VIERA Link (HDMI)-compatible Panasonic television (VIERA), the television automatically switches its input and the playback screen is displayed. For details (→251).
  - Read the operating instructions for the TV.

##### ■ Viewing 4K motion pictures on a PC screen

To play back 4K motion pictures on a PC, use the software "PHOTOfunSTUDIO".

- To play back and edit 4K motion pictures, a high-performance PC environment is required.
- For details, refer to the operating instructions of "PHOTOfunSTUDIO" (PDF).



#### Storing 4K motion pictures

##### ■ Storing 4K motion pictures on your PC

You can use the software "PHOTOfunSTUDIO" to import 4K motion pictures to a PC.

- For details, refer to the operating instructions of "PHOTOfunSTUDIO" (PDF).

## Viewing on TV screen

### Preparation

Turn off both camera and TV.

### 1 Connect camera to TV

Check the plug direction and insert it straight in. (Inserting these at an angle may cause deformation or malfunction) Also, do not insert into the wrong socket. Doing so may cause damage to this unit.

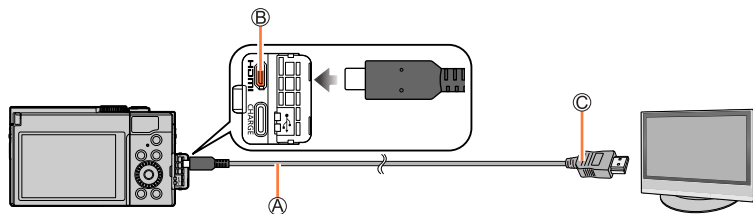

#### A HDMI micro cable

Use a High Speed HDMI micro cable (Type D–Type A plug) with the length less than 3 m (9.8 feet).

#### B [HDMI] socket

#### C To HDMI video/audio input socket

### 2 Turn on the TV and switch the TV input source to match the connection socket

### 3 Turn on the camera and press [▶] (Playback) button

- Bars may appear at the sides or at the top and bottom of the screen, depending on the aspect ratio setting.
- Change the screen mode on your TV if the picture is displayed with the top or bottom cut off.
- **With camera models DC-TZ99E/DC-TZ99GA/DC-TZ99GH/DC-TZ99GN:**  
Depending on the TV to be connected, motion picture files or 4K burst files may not be played back correctly.
- Check the [HDMI Mode (Play)]. (→201)
- Pictures are not displayed on the camera screen. Also, sound is not produced from the camera's speaker.
- HDMI output will be canceled if a USB connection cable is connected simultaneously.
- Read the operating instructions for the TV.

## VIERA Link (HDMI) (HDAVI Control™)

### What is VIERA Link (HDMI)?

- VIERA Link is a function that automatically links this camera to VIERA Link-compatible devices by connecting HDMI micro cables for enabling easy operation with the VIERA remote control. (Some operations are not available.)
- VIERA Link (HDMI) is an exclusive Panasonic function added to the industry-standard HDMI control functions known as HDMI CEC (Consumer Electronics Control). Operation is not guaranteed when connecting with non-Panasonic HDMI CEC-compatible devices. Refer to your product manual to verify compatibility with VIERA Link (HDMI).
- This camera supports VIERA Link (HDMI) Version 5. This is the Panasonic standard that also supports previous Panasonic VIERA Link devices.

### Preparation

Set [VIERA Link] to [ON] (→201).

- 1 Connect the camera to a VIERA Link (HDMI)-compatible Panasonic television (VIERA) with an HDMI micro cable (→250)**
- 2 Turn on the camera and press [▶] (Playback) button**
- 3 Operate with the remote control for the TV**

### Turning the unit OFF

- The camera can also be turned off when the television is turned off with the remote control.

### Automatic input select

- When the camera and TV are connected by HDMI micro cable, the camera is turned ON, and the camera's [▶] (Playback) button is pressed, the television input automatically switches to the camera's screen. The television can also be switched on via the camera from Standby Mode (if "Power on link" on the television is set to "on").

- Operations via the camera buttons will be limited.
- To play back the audio of the motion pictures in a slide show, set the [Sound] in the Slide Show setting screen to [AUTO] or [Audio].
- Use a High Speed HDMI micro cable (Type D–Type A plug) with the length less than 3 m (9.8 feet).
- If VIERA Link (HDMI) does not function correctly (→273)

## Storing recorded still pictures and motion pictures on your PC

Still/motion pictures can be copied from the camera to your computer by connecting the two together.

- Some computers can read directly from the camera's memory card.  
For details, see the instruction manual for your computer.

### ■ Computer specifications

You can connect the camera to a computer that can detect a mass storage device (device that stores a large volume of data).

- Windows: Windows 10, Windows 11
- Mac: macOS 13, 14, 15.0 - 15.1

## Storing recorded still pictures and motion pictures on your PC

## Downloading software

- To download the software, the PC must be connected to the Internet.
- It may take time to download the software in some communication environments.
- Supported OS versions as of December 2024. Supported OS versions may be changed without prior notice.

### PHOTOfunSTUDIO 10.0 AE

You can capture still pictures or motion pictures to your PC, or organize captured pictures by categorizing by recording date, model name of the digital camera used to record, etc. You can also correct still pictures, edit motion pictures, or write to DVD.

Check the website below to download/install the software.

The software is available for download until the end of January 2030.

[https://panasonic.jp/support/global/cs/soft/download/d\\_pfs10ae.html](https://panasonic.jp/support/global/cs/soft/download/d_pfs10ae.html)

#### • Operating environment

<b>Supported OS</b>	Windows® 8.1 (32-bit/64-bit) Windows® 10 (32-bit/64-bit) Windows® 11 • For 4K videos and 4K photos, the 64-bit version OS of Windows 8.1 or Windows 10, or Windows 11, is required.
<b>CPU</b>	Pentium® 4 2.8 GHz or higher
<b>Display</b>	1024×768 pixels or more (1920×1080 pixels or more recommended)
<b>RAM</b>	1 GB or more (32-bit) / 2 GB or more (64-bit)
<b>Free hard disk space</b>	450 MB or more for installing software

- For further information on the operating environment required for the playback and edit functions of 4K motion pictures and for the 4K photo cropping function, refer to the operating instructions for "PHOTOfunSTUDIO" (PDF file).
- "PHOTOfunSTUDIO" is not compatible with Mac.

## Storing recorded still pictures and motion pictures on your PC

**SILKYPIX Developer Studio SE**

This software develops and edits RAW file pictures. Edited pictures can be saved in a file format such as JPEG or TIFF that can be displayed on a PC, etc.

Check the website below to download/install the software.

<http://www.isl.co.jp/SILKYPIX/english/p/>

**• Operating environment**

<b>Supported OS</b>	Windows® 10 (64-bit) Windows® 11 macOS 10.13 to 10.15, 11, 12, 13, 14
---------------------	---

- For details on the operating environment and how to use the SILKYPIX Developer Studio, refer to the “Help” or the Adwaa’s support website.

## Storing recorded still pictures and motion pictures on your PC

## Copying still pictures and motion pictures

### Preparations

- Install “PHOTOfunSTUDIO” on your computer before starting the copying procedure. (→253)
- Turn on the camera and computer.

### 1 Connect camera to computer

- Check the plug direction and insert it straight in. (Inserting these at an angle may cause deformation or malfunction) Also, do not insert into the wrong socket. Doing so may cause damage to this unit.
- Use the supplied USB connection cable or a commercially available Type-C USB connection cable that complies with USB standards. (Depending on the country or area where the camera was purchased, the USB connection cable may not be supplied with the camera.)

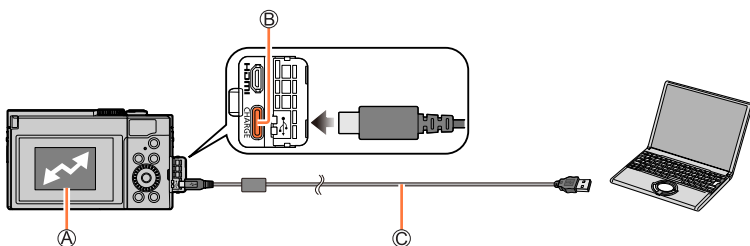

(A) [Access]

- Do not disconnect the USB connection cable while [Access] is displayed.

(B) [USB/CHARGE] socket

(C) USB connection cable

### 2 Use “PHOTOfunSTUDIO” to copy pictures to your computer

- Do not delete or move copied files and folders using Windows Explorer or other browsers. Otherwise, you will not be able to play back or edit the files using “PHOTOfunSTUDIO”.

- Before inserting or removing a card, turn the camera off and disconnect the USB connection cable. Otherwise, data may be destroyed.
- Take care not to turn off the camera while images are being imported.
- When the battery begins to run out during communication, a warning beep sounds. Remove the USB connection cable safely. Otherwise, data may be destroyed.

## Storing recorded still pictures and motion pictures on your PC

### ■ Copying to your computer without using “PHOTOfunSTUDIO”

You can save pictures to use on your computer by dragging and dropping folders and files into separate folders on your computer.

- The card of this unit contains the following files (folder structure).

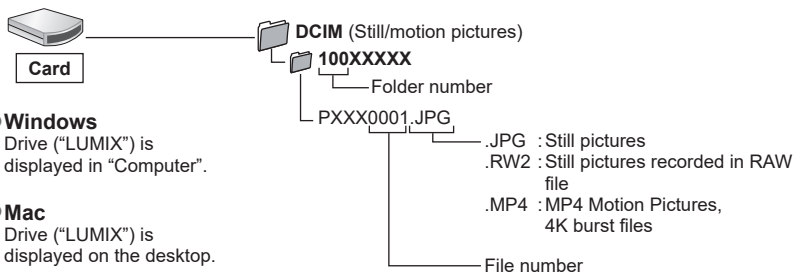

#### ● Windows

Drive (“LUMIX”) is displayed in “Computer”.

#### ● Mac

Drive (“LUMIX”) is displayed on the desktop.

## Storing recorded still pictures and motion pictures in the recorder

You can connect the camera to a Panasonic Blu-ray recorder or DVD recorder and store pictures from the camera on the recorder.

### Preparations

- Turn on the camera and recorder.

## 1 Connect camera to recorder

- Check the plug direction and insert it straight in. (Inserting these at an angle may cause deformation or malfunction) Also, do not insert into the wrong socket. Doing so may cause damage to this unit.
- Use the supplied USB connection cable or a commercially available Type-C USB connection cable that complies with USB standards. (Depending on the country or area where the camera was purchased, the USB connection cable may not be supplied with the camera.)

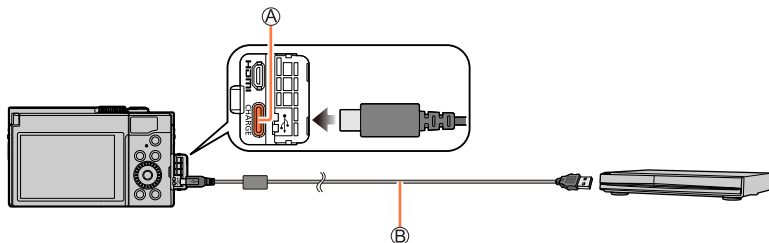

- Ⓐ [USB/CHARGE] socket  
 Ⓑ USB connection cable

## 2 Dub by operating the recorder

- For details on dubbing and playback procedures, refer to the operating instructions for the recorder.
- Some recorders may not support certain modes, such as the 4K motion picture mode.

- Take care not to turn off the camera while storage is in progress.
- Before inserting or removing a card, turn the camera off and disconnect the USB connection cable.

## Optional accessories

### Tripod Grip (Optional)

Attach a Tripod Grip (DMW-SHGR2: optional) to use it as a grip for recording while walking, a tripod, or a Shutter Remote Control.

- After attaching the tripod grip to the camera, connect the grip cable to the [USB/CHARGE] socket on the camera.

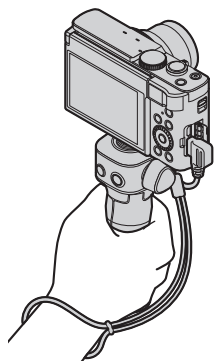

- You can turn off the camera by pressing the [SLEEP] button on the tripod grip. When you are ready to use it again, press the camera [ON/OFF] button to turn on the camera.
- Do not carry just by holding the hand strap of the Tripod Grip when the camera is attached.
- For details, refer to the operating instructions for the Tripod Grip.

## List of monitor displays

The screen display of the monitor indicates the camera's operating state.

- The information displayed, such as histograms, magnifications, and numeric values, are only for the purpose of reference.



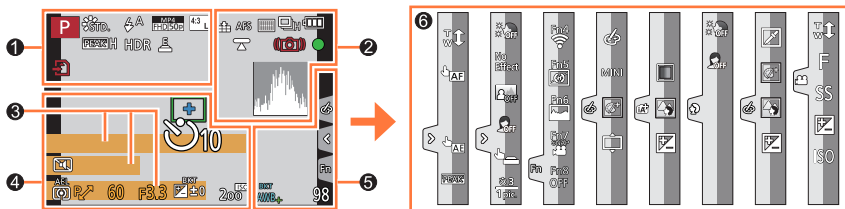























### In recording



	Recording mode (→38)
	Custom Set (→86)
	[Photo Style] (→169)
	Flash Mode (→145)
	[Rec Quality] (→151)
	[Snap Movie] (→155)
	[Aspect Ratio] (→167)/ [Picture Size] (→168)
	Picture effect (Filter) adjustment display (→76, 171)
EXPS	Types of picture effects (Filter) (→171)
	Card (displayed only during recording) (→27)

	Elapsed recording time*1 (→149)
	Simultaneous recording indicator (→154)
	[Peaking] (→187)
	[HDR] (→178)/[iHDR] (→56)
	Electronic shutter (→177)
	Overheat indicator (→269)

## List of monitor displays

<b>2</b>	 RAW	[Quality] (→168)	<b>3</b>	 Name* <sup>2</sup> (→194)
	240fps 120fps	[High Speed Video] (→82)		Travel elapsed days* <sup>3</sup> (→196)
	AFS AFF AFC MF	[AFS/AFF/AFC] (→89)/ MF (→101)		Age in years/months* <sup>2</sup> (→194)
		[AF Mode] (→90)		Location* <sup>3</sup> (→196)
		[Pull Focus] (→157)		Current date/time* <sup>3</sup>
		[Face Recog.] (→192)		Travel destination setting* <sup>3</sup> :  (→195)
	AFL	AF Lock (→103)		Exposure meter (→190)
		Burst (→112)		Zoom (→143)
		[4K PHOTO] (→114)	<b>4</b>	 AF area (→96)
		[Post Focus] (→125)		+ Spot metering target (→173)
		[Self Timer] (→130)		+ [Center Marker] (→188)
		Remaining battery (→23)		 [Self Timer] (→130)
	AF 	Macro recording (→100)		 [Zoom Mic] (→180)
		[Level Shot] (→179)		 [Silent Mode] (→176)
		[Stabilizer] (→139)		AEL AE Lock (→103)
		Jitter alert (→139)		 [Metering Mode] (→44, 173)
		Focus (Lights green.) (→37)/ Recording state (Lights up in red.) (→149)		 Program Shift (→64)
		Focus (Under low illumination) (→88)		60 Shutter speed (→37)
		Wi-Fi connection status		F3.3 Aperture value (→37)
		Bluetooth connection status (→229)		Exposure Compensation (→104)
	GPS	Location Logging (→239)		Exposure Bracket (→138)
		Histogram (→188)		Brightness (exposure) (→57, 80)
				Manual Exposure Assist (→68)
				 ISO sensitivity (→105)

## List of monitor displays

5

	<b>[Dial Guide]</b> (→186)
AWBc AWBw * ☁ ⚙ ⚙ [Fn] ☺	<b>White Balance</b> (→107)
BKT AWB+	<b>White Balance Bracket</b> (→110) <b>White Balance Fine Adjustment</b> (→109)
	<b>Coloring</b> (→56)
98	<b>Number of recordable pictures</b> (→28)
r20	<b>Maximum number of pictures that can be taken continuously</b> (→112)
RXXmXXs	<b>Available recording time*1</b> (→30)

6

## Touch tab (→185)

	<b>Touch zoom</b> (→144)
	<b>Touch Shutter</b> (→43)
	<b>Touch AF</b> (→43)
	<b>[Touch AE]</b> (→44)
	<b>[Peaking]</b> (→187)
	<b>Self Shot Mode</b> (→59)

	<b>Function buttons</b> (→49)
	<b>Coloring</b> (→57)
	<b>Defocus control function</b> (→57, 80)
	<b>Brightness (exposure)</b> (→57, 80)
	<b>Type of defocus ([Miniature Effect])</b> (→78)
	<b>[One Point Color]</b> (→79)
	<b>[Sunshine]</b> (→79)
	<b>Picture effect (Filter) adjustment display</b> (→76, 171)
	<b>Picture effects ON or OFF</b> (→171)
MINI	<b>Picture effects (Filter)</b> (→171)
F	<b>Aperture value</b> (→81)
SS	<b>Shutter speed</b> (→81)
ISO	<b>ISO sensitivity</b> (→81)
	<b>Scene Guide Mode</b> ([Soft Skin], [Slimming Mode]) (→72)

\*1 [h], [m] and [s] indicate “hour”, “minute” and “second”.

\*2 This is displayed for about 5 seconds when the camera is turned on if the [Profile Setup] setting is set.

\*3 This is displayed for about 5 seconds when the camera is turned on, after setting the clock and after switching from Playback Mode to Recording mode.

## In playback

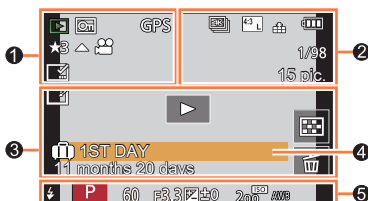

①









	Playback Mode (→208)
	Protected picture (→209)
GPS	With location information (→239)
★3	[Rating] (→209)
	Motion picture playback (→159)
	Continuous playback of picture group (→163)
	Save pictures from the 4K burst file (→117)
	Save a picture from pictures recorded using [Post Focus] (→127)
	Text stamped display (→217)
XXhXXmXXs	Elapsed playback time*1

②

	Icon indicating the presence of a marker (→118, 119, 120)
	4K Photo (4K burst file) (→114)
	[Post Focus] (→125)
	[Focus Stacking] (→128)
	[Aspect Ratio] (→167)/ [Picture Size] (→168)
	[Rec Quality] (→151)
	[Snap Movie] (→155)
	[Quality] (→168)
	240fps 120fps [High Speed Video] (→82)
	Remaining battery (→23)
	1/98 Picture number/Total pictures
	Wi-Fi connection status
	15 pic. Number of group pictures
	XXhXXmXXs Motion picture recording time*1 (→159)

## List of monitor displays

③

	Clear Retouch completed icon (→216)
	Acquiring information icon
	Playback (Motion Pictures) (→159)
 1ST DAY	Travel elapsed days (→196)
	Picture Group Display (→164)
	[Silent Mode] (→176)
	Multi Playback (→162)
	Delete (→165)

④

Name*2 (→192, 194)
Location*2 (→196)
Title*2 (→210)
Age in years/months (→192, 194)

⑤

Recording information
-----------------------

\*1 [h], [m] and [s] indicate "hour", "minute" and "second".

\*2 It is displayed in order of [Title], [Location], [Name] ([Baby1]/[Baby2], [Pet]), [Name] ([Face Recog.]).

## List of monitor displays

## Detailed information display

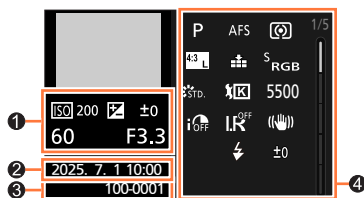

## Histogram display

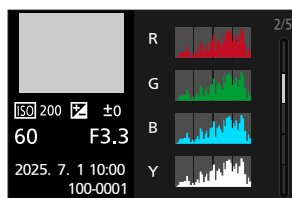

## Photo style display

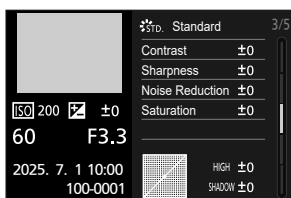

## White balance display

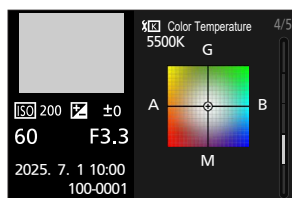

## Lens information display

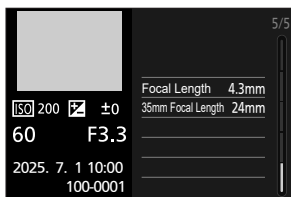

①

Recording information (Basic)

②

Recording date/time  
World time (→195)

③

100-0001 Folder/File number (→256)

④

Recording information (Advanced)

5500 White Balance (color  
temperature) (→107)

i OFF [i.Dynamic] (→174)

HDR ON [HDR] (→178)/[iHDR] (→56)

i.R OFF [i.Resolution] (→174)

## Message displays

The following explains the meaning of major messages displayed on the screen, and how to respond to them.

### ■ Memory cards

#### [Memory Card Error] / [Format this card?]

- Save needed data on a computer or other device, and then use [Format] on the camera. (→28)
- Try with a different card.

#### [Read Error] / [Write Error] / [Please check the card]

- Check whether card has been inserted correctly (→26).
- Turn off the camera and remove the card. Reinsert the card and turn the camera on again.
- Try with a different card.

#### [Recording was cancelled due to the limitation of the writing speed of the card]

- The speed class of a required card varies depending on [Rec Quality] of a motion picture. 4K photo recording requires a card that meets a particular speed class rating. Use a card that meets the rating. Be sure to use a card of the recommended speed class (→27).
- If recording stops even when using a card of the recommended speed class (→27), the data writing speed has dropped. If this happens, we recommend backing up the data on the memory card and formatting it (→28). Depending on the type of the card, recording may stop in the middle.

#### [Memory Card Error] / [This memory card cannot be used]

- Use a compatible card. (→27)

### ■ Battery

#### [This battery cannot be used]

- Use a genuine Panasonic battery. Consult the dealer or your nearest Service Center if display still remains.
- Wipe any dirt away from the battery terminal.

## ■ Others

### **[Some pictures cannot be deleted] / [This picture cannot be deleted]**

- Non-DCF pictures (→158) cannot be deleted. Save needed data on a computer or other device, and then use [Format] on the camera. (→28)

### **[Cannot be set on this picture]**

- [Title Edit], [Text Stamp], and other functions cannot be used for pictures that are not compliant with the DCF standard (→158).

### **[A folder cannot be created]**

- A folder cannot be created because available folder numbers have been already assigned. Save all necessary pictures to your computer or other devices and format the card (→28). After you format the card, execute [No.Reset] in the [Setup] menu to reset the folder number to 100. (→204)

### **[Please turn camera off and then on again] / [System Error]**

- Turn the camera on again. (Consult the dealer or your nearest Service Center if display still remains.)

## Q&A Troubleshooting

- ① Try checking these items (→267 - 274) first.

If the problem persists,

- ② Performing [Reset] in the [Setup] menu may resolve the issue (→204).  
 ③ Also, see the Panasonic support site for the latest support information.  
<https://panasonic.jp/support/global/cs/dsc/>  
 (This site is available in English only.)

### ■ Battery, power

#### The charging lamp blinks.

- Charging is being performed in a place with extremely high or low temperature.  
 → Reconnect the USB connection cable and retry charging in a place where ambient temperature is 10 °C to 30 °C (50 °F to 86 °F) (temperature conditions also apply to the battery itself).
- Charging is not possible if the power supply capacity of the computer is low.

#### Camera does not work even if the camera is turned on. Camera switches off as soon as the camera is turned on.

- Battery needs recharging.  
 → Charge the battery. (→19)
- [Power Button(At Power ON)] is set to [LONG-PRESS].  
 → If you set it to [SHORT-PRESS], you can turn on the camera by briefly pressing the camera [ON/OFF] button. (→198)

#### This unit is turned off automatically.

- [Power Save Mode] is activated. (→198)

#### The battery runs down quickly.

- [4K PHOTO] is set to [Pre-Burst] (4K Pre-Burst).  
 → When [Pre-Burst] (4K Pre-Burst) has been selected, the battery drains faster.  
 Select [Pre-Burst] (4K Pre-Burst) only when recording.
- The Wi-Fi connection has been on for a long time.  
 → The battery is used up faster with a Wi-Fi connection. Turn off the camera as often as possible using [Power Save Mode] (→198) or other methods.

## ■ Recording

### Striping or flicker may appear under lighting such as fluorescent lighting and LED lighting fixture.

- This is characteristic of MOS sensors which serve as the camera's pickup sensors. This is not a malfunction.
- If you are taking still pictures using the electronic shutter, the striping may be reduced by setting a slower shutter speed. (→67)
- When noticeable flicker or striping is seen under lighting such as a fluorescent or LED lighting fixture in the motion picture recording mode, you can reduce the flicker or striping by setting up [Flkr Decrease] (→179) and fixing the shutter speed. You can set the shutter speed manually in the Creative Video Mode. (→81)

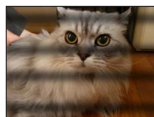

### Cannot record pictures. The shutter will not operate immediately when the shutter button is pressed.

- When [Focus/Release Priority] is set to [FOCUS], the camera will not record until proper focusing is achieved. (→184)

### Recorded pictures look white.

- Lens is dirty (fingerprints, etc.).  
→ Turn the camera on to extract lens barrel, and clean lens surface with a soft, dry cloth.

### Recorded pictures are too bright/too dark.

- AE Lock (→103) is set inappropriately.

### Some pictures are taken when I press the shutter button just once.

#### Check the following settings. If any of them apply, multiple pictures will be taken.

- Drive Mode is set to other than [Single].  
→ Set the Drive Mode to [Single]. (→111)
- Bracket recording is set.  
→ If any of the [BKT] icons (ex. [BKT±0], [BKT AWB], etc.) is displayed on the screen, bracket recording is set. Under [Bracket] in the [Rec] menu, set [Bracket Type] to [OFF]. (→137)

### Focus not aligned correctly.

- Subject outside of focus range.
- [Focus/Release Priority] is set to [RELEASE]. (→184)
- [Shutter AF] is set to [OFF]. (→182)
- AF Lock (→103) is set inappropriately.
- If there are fingerprints or dirt on the lens, the focus may be set to the lens and not the subject.

### Recorded pictures are blurred. The stabilizer function ineffective.

- Shutter speed is slower in dark locations and the stabilizer function is less effective.  
→ Use a tripod and the self-timer (→130) when using a slower shutter speed.

**Recorded pictures appear coarse, or there is interference.**

- We recommend trying the following methods.
  - Lower ISO sensitivity (→105).
  - Either adjust [Noise Reduction] of [Photo Style] to a higher setting or set each item other than [Noise Reduction] to a lower setting. (→170)

**Subject appears skewed in pictures.**

- If you take a picture of a moving subject in the electronic shutter mode, motion picture recording mode, or 4K photo recording mode, the subject in the picture may be skewed in some cases. This is characteristic of MOS sensors which serve as the camera's pickup sensors. This is not a malfunction.

**Brightness or coloring of recorded picture different from real life.**

- When recording under fluorescent or LED lighting fixture etc., increasing the shutter speed may introduce slight changes to brightness and color. These are a result of the characteristics of the light source and do not indicate a malfunction.
- When recording subjects in extremely bright locations or recording under fluorescent lighting, LED lighting fixture, mercury lamp, sodium lighting etc., the colors and screen brightness may change or horizontal striping may appear on the screen.

**4K photo recording stops before finishing.**

- When the ambient temperature is high or recording of the 4K Photo function is performed continuously, the camera may display [, ] and stop the recording. Wait until the camera cools down.

## ■ Motion Picture

### Cannot record motion pictures.

- When a large capacity card is used, you may not be able to take a picture for a while after you turn on the camera.

### Motion picture recording stops midway.

- When the ambient temperature is high or motion picture is recorded continuously, the camera may display [>] and stop the recording. Wait until the camera cools down.
- The speed class of a required card varies depending on [Rec Quality] of a motion picture. Be sure to use a card of the recommended speed class ([→27](#)).

### Sometimes focus adjustment with Auto Focus mode is difficult while recording 4K motion pictures.

- This may occur when taking a picture by reducing the Auto Focus speed in order to adjust the focus at high precision. This is not a malfunction.

### A noise, such as a clicking or buzzing noise, is recorded on a motion picture. Audio is recorded at low volumes.

- With recording in a quiet environment, the sound of aperture, focus and other actions may be recorded in motion pictures. This is not a malfunction. The focus operation during recording of motion pictures can be set to [OFF] in [Continuous AF] ([→153](#)).
- If you block the microphone with your fingers while motion pictures are being recorded, the audio may be recorded at a low volume or may not be recorded at all. In this case, the camera may pick up the lens operating sounds more easily.

### Operating sounds are recorded in a motion picture.

- We recommend recording motion pictures in Creative Video Mode if you are concerned about operating noise. ([→81](#))

## ■ Flash

### No flash emitted.

- The flash becomes unavailable in the following cases.
  - Flash set to [>] (Forced Flash Off). ([→145](#), [146](#))
  - Set [Shutter Type] to [AUTO] or [MSHTR]. ([→177](#))
  - Set [Silent Mode] to [OFF]. ([→176](#))

## ■ Monitor

### The monitor is turned off although the camera is turned on.

- If no operations are performed during the set time period [Auto Monitor Off] (→198) is activated, and the monitor turns off.

### It may flicker for an instant or the brightness of the screen may change significantly for an instant.

- This occurs due to the aperture of the lens changing when the shutter button is pressed halfway, or when the brightness of the subject changes. This is not a malfunction.

## ■ Playback

### Cannot view pictures. There are no recorded pictures.

- A card is not inserted in the camera.
- Has the file name of the picture been changed on a computer? If so, it cannot be played back on the camera.
  - It is recommended to use the "PHOTOfunSTUDIO" software (→253) to write pictures from PC to card.
- Set [Playback Mode] to [Normal Play]. (→208)

## ■ Wi-Fi function

### A connection cannot be established. Radio waves get disconnected.

- Bring the device (smartphone, etc.) you want to connect to closer to the camera to communicate. (The communication distance varies greatly depending on the usage environment, etc.)
- Is any device, such as microwave oven, cordless phone, etc., that uses 2.4 GHz frequency operated nearby?  
→ Radio waves may get interrupted when used simultaneously. Use them sufficiently away from the device.
- If the device (smartphone, etc.) you want to connect to is connected to a wireless access point other than the camera, you will not be able to connect the device to the camera. Change the Wi-Fi settings of the device you want to connect to so that the access point to be used is set to the camera.
- When the battery indicator is flashing red, the connection with other equipment may not start or the connection may be disrupted. (A message such as [Communication error] is displayed.)
- When this unit is placed on a metal table or shelf, the connection may not be established easily. Use the camera away from metal surfaces.

### This unit is not displayed in the Wi-Fi setting screen of the smartphone.

- Try switching the ON/OFF of the Wi-Fi function in the Wi-Fi settings of the smartphone.

### Transmission of the image fails midway. There is an image that could not be transmitted.

- Is the size of the image too large?  
→ Transmit after dividing the motion picture with [Video Divide] (→220).  
→ Reduce the image size at [Size] (→244), and then send.
- About picture file formats that can be transmitted (→237, 242)

### I have forgotten the password for the Wi-Fi.

- Execute the [Reset Network Settings] in the [Setup] menu. (→204)  
However, the information you have set on the [Wi-Fi Setup] or [Bluetooth] will be reset.

## ■ TV, computer

### No image appears on TV. Image blurred or not colored.

- Not connected correctly (→250).
- The television has not been switched to auxiliary input.

### VIERA Link (HDMI) is not working.

- Is the camera's [VIERA Link] setting set to [ON]? (→201)  
→ Check the VIERA Link (HDMI) settings on the device you are connecting to.  
→ Turn the camera off and on again.

### Computer does not recognize card. (When using an SDXC Memory Card)

- Check whether your computer is compatible with SDXC Memory Cards.
- A message prompting you to format the card may appear when you connect it. Do not format the card.
- If the [Access] indicator on the screen does not go off, turn the camera off before disconnecting the USB connection cable.

## ■ Others

### The lens makes a clicking noise.

- When the camera is turned on or off, the lens is moved, or an aperture operation is performed, such a noise may be heard. This is not a malfunction.
- When the brightness changes after a zooming operation or moving the camera, the lens may make a noise while adjusting the aperture. This is not a malfunction.

### Zooming stops instantaneously.

- When using the Extended/Extra optical zoom, the zooming action will stop temporarily. This is not a malfunction.

### Red lamp illuminated when pressing shutter button halfway in dark locations.

- [AF Assist Lamp] is set to [ON] (→183).

### Camera is hot.

- Camera may become a little warm during use, but this does not affect performance or quality.

### Clock is incorrect.

- If you do not use the camera for a long time, the clock may be reset.  
→ Reset the clock (→32).

### When using zoom, picture becomes slightly warped and the edges of the subject become colored.

- Pictures may be slightly warped or colored around the edges, depending on the zoom ratio, but this is not a fault.

## Usage cautions and notes

### When in use

- **Keep this unit as far away as possible from electromagnetic equipment (such as microwave ovens, TVs, video games etc.).**
  - If you use this unit on top of or near a TV, the pictures and/or sound on this unit may be disrupted by electromagnetic wave radiation.
  - Do not use this unit near cell phones because doing so may result in noise adversely affecting the pictures and/or sound.
  - Recorded data may be damaged, or pictures may be distorted, by strong magnetic fields created by speakers or large motors.
  - Electromagnetic wave radiation may adversely affect this unit, disturbing the pictures and/or sound.
  - If this unit is adversely affected by electromagnetic equipment and stops functioning properly, turn this unit off and remove the battery or disconnect AC adaptor. Then reinsert the battery or reconnect AC adaptor and turn this unit on.

**Do not use this unit near radio transmitters or high-voltage lines.**

- If you record near radio transmitters or high-voltage lines, the recorded pictures and/or sound may be adversely affected.
- Do not extend cords or cables that are supplied with the camera or supplied with optional accessories.
- Do not allow camera to come into contact with pesticides or volatile substances (can cause surface damage or coating to peel).
- Keep credit cards and other items sensitive to magnetism away from the magnetic portion of the camera. Otherwise, magnetic fields may damage their data and make them unusable.

Ⓐ Magnet

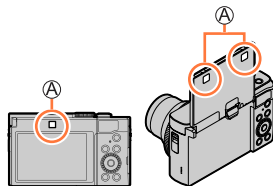

- Never leave the camera and the battery in a car or on a car hood in the summer. Doing so may cause leakage of the battery electrolyte, overheating, fire or a battery explosion due to the high temperature.

### Caring for your camera

To clean your camera, remove the battery, card (optional), or disconnect the power plug from the outlet, and wipe with a soft, dry cloth.

- Use a damp cloth to remove stubborn stains, before wiping with a dry cloth.
- Do not use benzine, thinners, alcohol, or kitchen detergent, as these may damage the outer casing and finish of the camera.
- If using a chemically-treated cloth, read the supplied instructions carefully.
- Do not touch the lens barrier.

Ⓐ Lens barrier

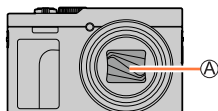

### When not using for a while

- Turn off the camera before removing battery and card.
  - Ensure that battery is removed to prevent damage through over-discharge.
  - Clock settings will be saved for approx. 3 months even after the battery is removed, provided a fully charged battery was installed in the camera for 24 hours beforehand.
- Do not leave in contact with rubber or plastic bags.
- Store together with a drying agent (silica gel) if leaving in drawer, etc. Store batteries in cool (15 °C to 25 °C (59 °F to 77 °F)) places with low humidity (40%RH to 60%RH) and no major temperature changes.
- Charge battery once per year and use completely before storing again.
- Check all the parts before taking pictures when you have not used the camera for a long period of time.

### Monitor

- Do not press hard on the monitor. This may cause uneven display and damage the monitor.
- In cold climates or other situations when the camera becomes cold, the monitor may appear slightly darker than normal immediately after the camera is turned on. Normal brightness will return once the internal components have warmed up.

The monitor is made with extremely high precision technology. However there may be some dark or bright spots (red, blue or green) on the screen. This is not a malfunction. The monitor screen is controlled with extremely high precision, but some pixels may be inactive. The spots will not be recorded on pictures on a card.

## Lens

- Do not press the lens with excessive force.
- Do not irradiate the camera (lens) directly with strong light beams such as laser beams. Doing so may damage the image sensor and cause the camera to malfunction.
- Images may appear slightly white if lens is dirty (fingerprints, etc.). Turn the camera on, hold the extracted lens barrel with your fingers, and gently wipe the lens surface with a soft, dry cloth.
- Do not leave the camera with the lens facing the sun as rays of light from the sun may cause it to malfunction. Also, be careful when placing the camera outside or near a window.
- Do not touch the lens barrier, as this may damage the lens. Be careful when removing camera from bag, etc.

## Battery

The battery is a rechargeable lithium ion battery.

This battery is easily affected by temperature and humidity, and is affected more when the temperature is high or low.

- Remove battery from camera after use.
  - Keep the battery in a plastic bag, making sure that it is kept away from metallic objects (such as clips) when carrying or storing it.
- The time required for charging varies depending on conditions of battery usage. Charging takes longer at high or low temperatures and when the battery has not been used in some time.
- Battery will be warm during charging and for some time thereafter.
- Battery will run out if not used for long periods of time, even after being charged.
- Do not leave any metal items (such as clips) near the contact areas of the power plug. Otherwise, a fire and/or electric shocks may be caused by short-circuiting or the resulting heat generated.
- Frequently charging up battery is not recommended.  
(Frequently charging battery reduces maximum usage time and can cause battery to expand.)
- If available battery power is significantly reduced, battery is reaching end of lifespan. Please purchase a new battery.
- When charging:
  - Wipe dirt from the battery terminal with a dry cloth.
  - Keep at least 1 m (3.3 feet) away from AM radio (may cause radio interference).
- Do not use a damaged or dented battery (especially connectors), e.g. by dropping (can cause faults).

### AC adaptor

- The [CHARGE] light may blink under the influence of static electricity or electromagnetic wave, depending on the charging environment. This phenomenon has no effects on charging.
- If you use the AC adaptor near a radio, the radio reception may be disturbed. Keep the AC adaptor 1 m (3.3 feet) or more away from radio.
- The AC adaptor (supplied) may generate whirring sounds when it is being used. This is not a malfunction.
- After use, be sure to disconnect the power plug from the electrical outlet. (A very small amount of current is consumed if it is left connected.)

### Memory cards

- To prevent damage to cards and data
  - Avoid high temperatures, direct sunlight, electromagnetic waves, and static electricity.
  - Do not bend, drop, or expose to strong impacts.
  - Put the card in the card case or the storage bag after use and when storing or carrying the card.
  - Do not touch terminals on reverse of card or allow them to become dirty or wet.
- Recorded data may be damaged or lost if the camera breaks down due to inappropriate handling. Panasonic will not be liable for any damage caused due to loss of recorded data.
- When disposing of/transferring memory cards
  - If using the “format” or “delete” functions on your camera or computer, this only changes the file management information, and does not completely delete the data from within the memory card. When disposing of or transferring your memory cards, we recommend physically destroying them, or using commercially available computer data erasing software to completely delete the data from the card. Data within memory cards should be managed responsibly.

### When using a tripod or unipod

- Do not apply excessive force or tighten screws when they are crooked. (This may damage the camera, screw hole, or label.)
- Ensure that the tripod is stable. (Refer to the tripod instructions.)
- You may not be able to remove the card or the battery when using a tripod or unipod.

## Personal Information

- If names or birthdays are set in [Profile Setup] or in the [Face Recog.] function, keep in mind that the camera and recorded pictures will contain personal information.
- **Be sure to pay special attention to the privacy, likeness rights, etc. of a subject and take your own responsibility when you use the [Silent Mode], or use functions such as writing the location information and changing the shutter noise, etc.**
- To protect personal information, we recommend that you set a Wi-Fi function lock. (→248)
- When setting a password, please observe the following.
  - Avoid using passwords that are easy for a third party to guess, such as your birthday.
  - Set a password that is different from the password you use for other services.
- **Disclaimer**
  - Data containing personal information can be altered or lost due to malfunction, static electricity, accidents, breakdowns, repairs, or other operations. Panasonic will not be liable for any damage that occurs, direct or indirect, as a result of the alteration or loss of data containing personal information.
- **When ordering repairs or transferring/disposing of the camera**
  - After you make a note of the personal information, perform [Reset Network Settings] to delete data containing personal information such as wireless LAN connection settings that you registered or set in this unit. (→204)
  - To protect your personal information, please reset the settings. (→204)
  - Remove the memory card from the camera.
  - When ordering repairs, settings may be returned to the initial purchase state.
  - If the above operations cannot be performed because of a camera malfunction, consult with the dealer or nearest Service Center.
- **When transferring or disposing of your memory card, see “When disposing of/ transferring memory cards” in the previous section. (→278)**
- **Uploading pictures to WEB services**
  - Pictures may contain personal information that can be used to identify the user, such as titles, recording dates and times, and location information. Before uploading the pictures to WEB services, check the pictures carefully for information that should not be disclosed.

## Wi-Fi function

### ■ Use the camera as a wireless LAN device

When using equipment or computer systems that require more reliable security than wireless LAN devices, ensure that the appropriate measures are taken for safety designs and defects for the systems used. Panasonic will not take any responsibility for any damage that arises when using the camera for any purpose other than as a wireless LAN device.

### ■ Use of the Wi-Fi function of this camera is presumed to be in countries where this camera is sold

There is the risk that the camera violates the radio wave regulations if used in countries other than those where this camera is sold, and Panasonic takes no responsibility for any violations.

### ■ There is the risk that data sent and received via radio waves may be intercepted

Please note that there is the risk that data sent and received via radio waves may be intercepted by a third party.

### ■ Do not use the camera in areas with magnetic fields, static electricity or interference

- Do not use the camera in areas with magnetic fields, static electricity or interference, such as near microwave ovens. Radio waves may not reach the camera.
- Using the camera near devices such as microwave ovens or cordless telephones that use the 2.4 GHz radio wave band may cause a decrease in performance in both devices.

## Usage cautions and notes

- SDXC Logo is a trademark of SD-3C, LLC.
- The terms HDMI, HDMI High-Definition Multimedia Interface, HDMI Trade dress and the HDMI Logos are trademarks or registered trademarks of HDMI Licensing Administrator, Inc.
- USB Type-C® and USB-C® are registered trademarks of USB Implementers Forum.
- HDAVI Control™ is a trademark of Panasonic Holdings Corporation.
- Adobe is a trademark or registered trademark of Adobe Systems Incorporated in the United States and/or other countries.
- Pentium is a trademark of Intel Corporation in the U.S. and/or other countries.
- Windows is either registered trademark or trademark of Microsoft Corporation in the United States and/or other countries.
- Mac and macOS are trademarks of Apple Inc., registered in the U.S. and other countries.
- App Store is a service mark of Apple Inc.
- Google, Android and Google Play are trademarks of Google LLC.
- The Bluetooth® word mark and logos are registered trademarks owned by Bluetooth SIG, Inc. and any use of such marks by Panasonic Holdings Corporation is under license. Other trademarks and trade names are those of their respective owners.
- “Wi-Fi®” is a registered trademark of Wi-Fi Alliance®.
- “WPA™”, and “WPA2™” are trademarks of Wi-Fi Alliance®.
- QR Code is a registered trademark of DENSO WAVE INCORPORATED.
- Other names, company names, and product names mentioned in these instructions are trademarks or registered trademarks of the companies concerned.



This product incorporates the following software:

- (1) the software developed independently by or for Panasonic,
- (2) the software owned by third party and licensed to Panasonic,
- (3) the software licensed under the GNU General Public License, Version 2.0 (GPL V2.0),
- (4) the software licensed under the GNU LESSER General Public License, Version 2.1 (LGPL V2.1), and/or
- (5) open source software other than the software licensed under the GPL V2.0 and/or LGPL V2.1.

The software categorized as (3) - (5) are distributed in the hope that it will be useful, but WITHOUT ANY WARRANTY, without even the implied warranty of MERCHANTABILITY or FITNESS FOR A PARTICULAR PURPOSE. Please refer to the detailed terms and conditions thereof displayed by selecting [MENU/SET] → [Setup] → [Version Disp.] → [Software info].

At least three (3) years from delivery of this product, Panasonic will give to any third party who contacts us at the contact information provided below, for a charge no more than our cost of physically performing source code distribution, a complete machine-readable copy of the corresponding source code covered under GPL V2.0 or LGPL V2.1, as well as the respective copyright notice thereof.

Contact Information: [oss-cd-request@gg.jp.panasonic.com](mailto:oss-cd-request@gg.jp.panasonic.com)

The source code and the copyright notice are also available for free in our website below.  
<https://docs.connect.panasonic.com/oss/>

### Ecodesign information

The following is Ecodesign information required by EU Commission Regulation.

- For guidance on how to activate and deactivate the wireless network port, see:
  - [Wi-Fi/Bluetooth:222](#)

This product is licensed under the AVC Patent Portfolio License for the personal use of a consumer or other uses in which it does not receive remuneration to (i) encode video in compliance with the AVC Standard ("AVC Video") and/or (ii) decode AVC Video that was encoded by a consumer engaged in a personal activity and/or was obtained from a video provider licensed to provide AVC Video. No license is granted or shall be implied for any other use. Additional information may be obtained from MPEG LA, L.L.C.

See <http://www.mpegla.com>

### Disposal of Old Equipment and Batteries Only for European Union and countries with recycling systems



These symbols on the products, packaging, and/or accompanying documents mean that used electrical and electronic products and batteries must not be mixed with general household waste.

For proper treatment, recovery and recycling of old products and used batteries, please take them to applicable collection points in accordance with your national legislation.

By disposing of them correctly, you will help to save valuable resources and prevent any potential negative effects on human health and the environment.

For more information about collection and recycling, please contact your local authority.

Penalties may be applicable for incorrect disposal of this waste, in accordance with national legislation.



#### **Note for the battery symbol (bottom symbol):**

This symbol might be used in combination with a chemical symbol. In this case it complies with the requirement set by the Directive for the chemical involved.

# Firmware Update

- **Firmware Ver. 1.4:** (→F-3)

The firmware has been updated to improve camera capabilities, add functionality, and enhance security.

The following pages describe the details of the firmware update.

- To check the firmware version of the camera, select [Version Disp.] in the [Setup] menu.
- For the latest information on the firmware or to download/update the firmware, visit the following support site:

**<https://panasonic.jp/support/global/cs/dsc/download/index2.html>**  
(English only)

## About Applications

When you have updated the firmware for the camera, use the latest version of the application for your smartphone.

---

### “Image App”

- Install or update the application on your smartphone.
-

## Functional Changes to Enhance Security

### Changes to Wi-Fi Functionality

In order to enhance security, you can now change the password for this camera when connecting it to a smartphone directly via Wi-Fi.

The menu item [Device Name] in [Wi-Fi Setup] has been changed to [Device Name/Password].

**MENU** →  **[Setup]** → **[Wi-Fi]** → **[Wi-Fi Setup]**

**[Device Name/Password]**  
You can change the camera name (SSID) and password.

**[Device Name]**

**[Password]**

- ① Press [DISP.] button
- ② Enter any device name or password
  - The number of characters you can enter is a maximum of 32 for the device name and between 8 and 63 for the password.

- For details on how to enter characters, refer to “Entering Text” ([→52](#))
- If you forget the password, you can reset it with [Reset Network Settings] ([→204](#)) in the [Setup] menu.